

SHAD

ENGINEERED FOR RIDING

PIONEERS / EXPANDABILITY



WWW.SHAD.ES

SET NEW SH51 TOPCASE / SH38X EXPANDABLE SIDE CASE

INDEX

CASES

TERRA TR55 P. 22	TR48 P. 22	NEW TR46 P. 24	TR41 P. 25	TR47 P. 26	TR36 P. 26	NEW TR27 P. 28	
							
TOP SH59X ALUMINIUM P. 32	SH58X CARBON P. 33	NEW SH51 P. 34	SH48 P. 36	SH47 P. 37	SH46 P. 38	SH45 P. 39	SH44 P. 40
							
SH40 P. 41	SH40 CARGO P. 42	SH39 P. 43	SH34 P. 44	SH33 P. 45	SH29 P. 46	SH26 P. 47	
							
SIDE SH38X P. 54	SH38X CARBON P. 55	SH36 P. 56	SH35 P. 57	SH23 P. 58			
							

- THE COMPANY** P. 4
- NEW 2026** P. 18
- ACCESSORIES FOR MOTOR CASES** P. 59
- FITTING KITS** P. 60
- COMFORT SEATS** P. 65

BAGS

TERRA TR40 P. 68	TR30 P. 69	TR50 P. 70	NEW TR08 P. 71	TR15 P. 74	TR10 P. 75			
								
CLICK SYSTEM E09PRO P. 76	E09CLD P. 76	E09c P. 76	E09cm P. 77	E03 CL PRO P. 78	E03cl P. 78	E03c P. 78	E02c P. 78	
								
TOURING NEW SL58 P. 80	NEW SL20F P. 80	NEW SL12M P. 81	NEW SL86 P. 81	NEW SL05 P. 82	NEW SL04 P. 82	NEW SL03 P. 82	SL01 P. 83	SC25 P. 83
								
SPORT E04 P. 83	E48SR P. 84	E48 P. 85	CAFE RACER SR38 P. 85	WATERPROOF SW80 P. 86	SW38 P. 87	IB08 P. 87		
								

- EXHIBITIONS** P. 98
- DISPLAY** P. 99
- ICONS** P. 103
- SPARE PARTS** P. 103
- SHAD SUPPORT** P. 103
- SPR PRICE LIST** P. 104

RIDER	SMARTPHONE HOLDERS P. 88	
	RAIN JACKETS P. 90	
	RAIN PANTS P. 90	
	HAND MUFFS P. 90	
ATV CASES	ATV110 P. 90	
	ATV80 P. 90	
	ATV40 P. 90	
LOCKS	SHAD LOCKS P. 94	
	DISK LOCKS P. 96	

THE COMPANY



NAD-SHAD

The NAD S.L. to which part SHAD is of has more than 50 years of experience and is the market leader in the manufacturing of seats and cases for motorcycles of all major world brands in the sector. The production centers of seats, cases and fitting kits are located closed to Barcelona, with branch offices in China, USA, Indonesia, and Phillipines.



INNOVATION

Engineering and design have always been our hallmarks. We develop leading products in both our technical department and in cooperation with the engineering teams of major motorcycle brands. Our commitment to R&D has provided numerous innovative solutions for the market, that have made earned us various patents and design awards.

ENGINEERED FOR RIDING

DESIGNED IN BARCELONA

Since 1973



SEATS

The production of motorcycle seats marked the origin of the NAD company. In our 50+ year history, we have transitioned from an almost artisanal production to becoming leaders in the manufacture of OEM seats, with top clients such as BMW, Yamaha, Harley Davidson, Indian, Triumph. Our ability to adapt to the needs of our customers has allowed us to win the trust of major manufacturers around the world.



CASES

The quality of our products has led us to become worldwide leaders in the manufacturing of OEM cases. A little more than 30 years ago, we started to develop our own brand, SHAD, which from the very beginning has stood out for its quality, design and functionality. These qualities have strengthened its market position, while earning its recognition in the sector with numerous international awards.

OUR CUSTOMERS



SHAD WORLD

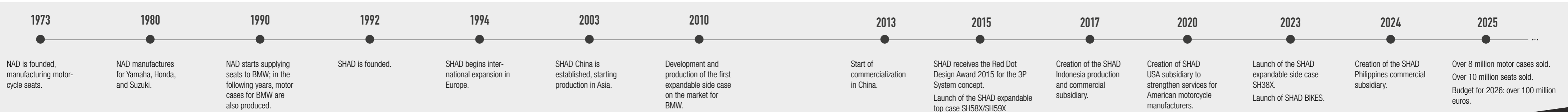

DESIGN & INNOVATION PROCESS



RESEARCH TO INNOVATE

User feedback and analysis on how our solutions will be used in practice are the starting point. We combine market data, technology, and experience to detect opportunities for improvement or innovation. As a result, we define functional concepts that are viable and aligned with new mobility habits.

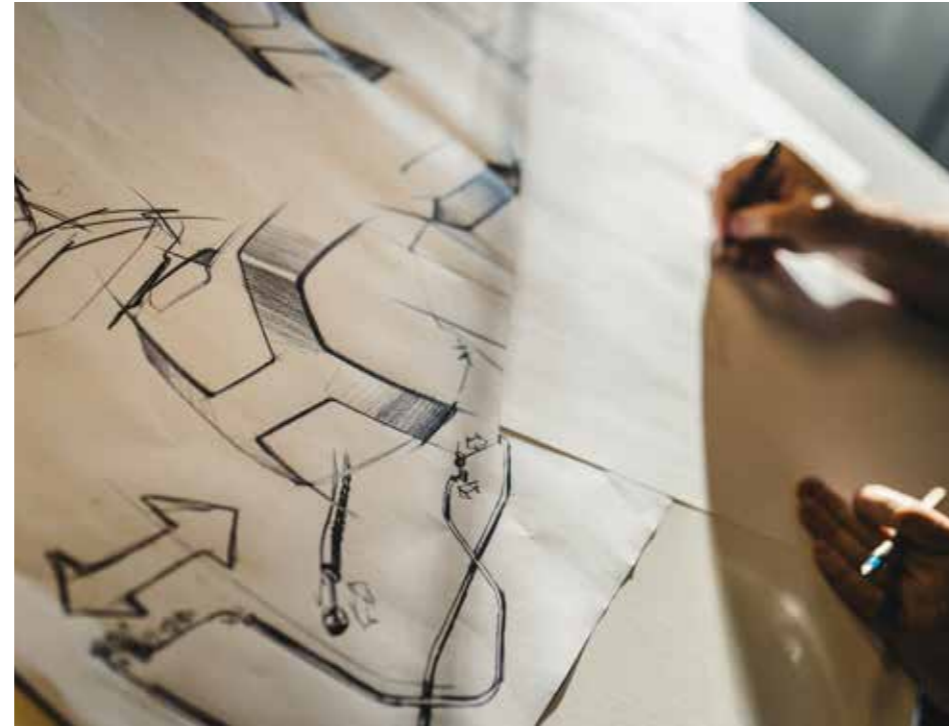

USER-CENTERED DESIGN

Each product is born from the integration of design and engineering. Our in-house team works transversally to solve technical, ergonomic and aesthetic challenges. The result is functional, durable solutions that are consistent with the rider's experience.

ENGINEERED FOR RIDING



FROM MODEL TO TESTING

We transform ideas into real solutions through prototyping and technical validation. We evaluate volume, aerodynamics, accessibility and aesthetics with foam or clay models and functional samples. Each iteration brings us closer to the final version of the product.



FROM ENGINEERING TO PRODUCTION

We integrate the entire value chain: design, validation, industrialization and production. This control allows us to guarantee quality at every stage. We work with specialized factories in Barcelona, Jakarta, and Shanghai, combining local and global capabilities to create reliable and durable products for both SHAD and leading motorcycle brands.

DESIGNED IN BARCELONA

Since 1973

QUALITY CASES LAB



LABORATORY TESTS:

Metrology scanning

Crash Test

Traction Test

Weathering Test

Textile Waterproofness Test

Shaker Test

Water resistance Test

Paint adherence Test

Dust resistance Test

Foam Compression Test

The quality of our products is based on continuous improvement, management excellence and customer satisfaction. We test our products in both static and dynamic tests, during all stages of development process and through each production, thus guaranteeing compliance with rigorous quality standards.

To test a case, we perform over 1,000 hours of laboratory testing in more than 20 different types of lab tests. Thanks to this quality testing, our products are designed to offer a long service life, ensuring performance, safety and durability over time.

We work on delivering the best final product to customer. That is why in SHAD we design, engineer and manufacture products covering all production stages under our constant testing control, since 1973.

ENGINEERED FOR RIDING



DYNAMIC TESTS:

We carry out dynamic road tests to study how our products perform in changing situations or under load over time. To test an adventure case, we travel more than 10,000 km in different conditions.

Functional prototypes lay on hands of the most experienced riders to ensure maximum resistance in extreme real conditions.

The dynamic tests, that challenge expert riders as the Dakar legend Joan Pedrero, let our engineering team adjust any fine tuning detail to its perfection.

DESIGNED IN BARCELONA

Since 1973

SUSTAINABILITY ACTIONS



Efficient factories:
Lower resource use per unit produced.



Durable design:
High quality and long-lasting products.



Circular economy:
We repurpose waste with specialized partners.



Repairable:
Spare parts available and easy to maintain.



DESIGNED TO LAST

TIMELESS. DURABLE. REPAIRABLE.
WITH PARTS & SUPPORT TO EXTEND PRODUCT LIFE.



SPARE PARTS



Check here the spare parts for your case

SHAD SUPPORT



YOUTUBE SUPPORT CHANNEL:
Technical info
Spare parts installation
Accessories mounting guide

SOCIAL RESPONSIBILITY



For years, SHAD has maintained collaboration and sponsorship agreements with organisations of our local community. These actions range from supporting organisations such as the Red Cross, UNICEF, or the Hospital Sant Joan de Déu, to sponsoring the CF Mollet UE Genuine team and the CB Mollet 3x3 wheelchair basketball team. The main objective of these agreements is to promote solidarity and inclusive sports, aligning their values of integration and effort with those of our company.



SHAD RIDER

Anyone who acquires a SHAD product is not just a customer — that action turns him/her into a **#shadrider**. Riders who share their adventures around the world through social media, creating a community that grows every day. More than a hundred riders sent images of their daily lives to the photo contest we organised, proudly showing their sense of belonging to the **#shadrider** community.

This spirit has also spread to our employees, some of whom took on the challenge of motorcycle touring by participating in the demanding Rider 500.



@allhiisforme

@de_paseo_en_moto

@revistamotoviajeros

@josephsquare21

@lacovid20



Rider 500

SPONSORSHIPS



SHAD's relationship with the motorcycling world is part of the company's DNA. Our brand awareness is carried out through international competitions such as the World Superbike Championship, and motorcycle touring events like the HAT Series or the 100 Colls. We also support renowned riders such as Joan Pedrero, Pol Tarrés, and Romain Dumontier (third place in the latest edition of the Dakar Rally).



-  SHADmotorcycles
-  shad_motorcycles
-  SHAD motorcycles

INNOVATION HIGHLIGHTS



INTEGRATED FITTING SYSTEM

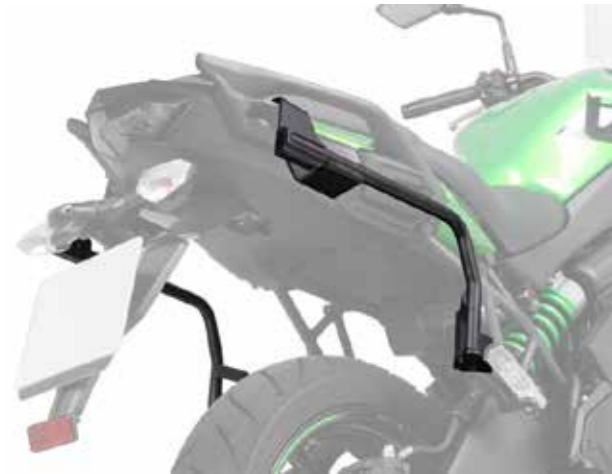

2015
PATENTED



The 3P System is the almost invisible side cases and bags fitting. It integrates its aesthetic into the motorcycle and allows a solid mounting with just 3 anchor points.



PIONEERS IN EXPANDABILITY

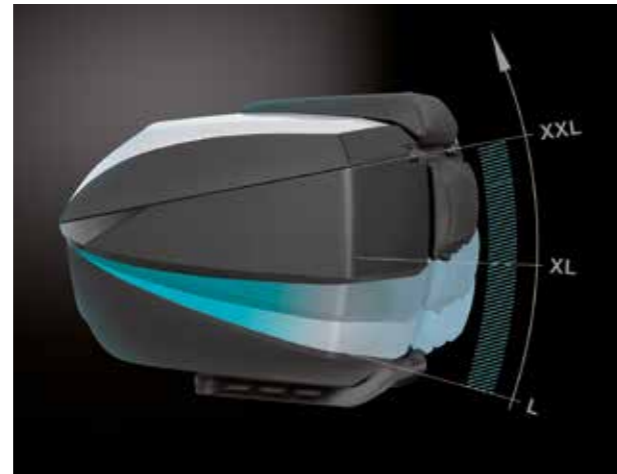

2016
PATENTED



Innovation came after the research. In SHAD we created the first expandable top and side cases for the aftermarket.

Based on axial expansion, our top cases SH58X and 59X increase their volume in 3 possible positions.

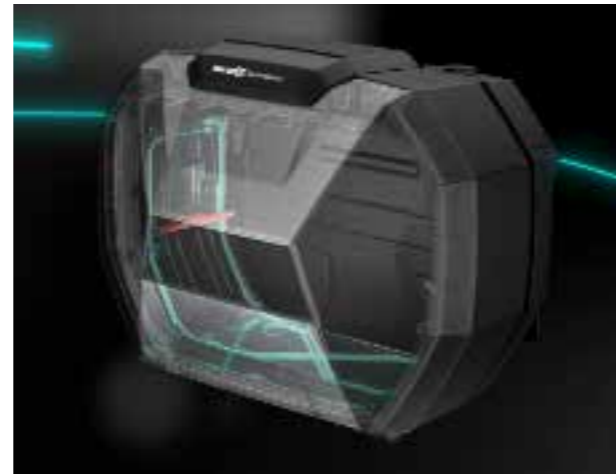

SH38X

2024
PATENTED

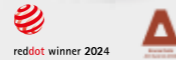

A dynamic tensegrity system allows our SH38X to expand in a smooth telescopic way, up to one helmet capacity.

Now it is possible to adjust the 40% of capacity to every journey.

ENGINEERED FOR RIDING



EQUIPMENT WITH MECHANISMS FOR YOUR ADVENTURE MODE



2018
PATENTED



Designed for adventure touring our premium aluminum TERRA CASES combine strength, security, and style for long-distance travel.



2022
PATENTED



Versatile and lightweight luggage solutions, our TERRA BAGS offer maximum resistance and minimum weight. Double security system is included in saddle bags. Perfect for any adventure trip.



MECHANICAL SYSTEM FOR TANK BAGS



2023
PATENTED



The SHAD Click System is the latest evolution in motorcycle tank bag fittings, designed to offer comfort, safety, and quick installation. Its discreet integration and advanced technology, allows you to attach and release the bag with a single movement.

DESIGNED IN BARCELONA
Since 1973

NEW 2026

NEW SH51

Pag. 34



NEW TR46

Pag. 24



NEW TR27

Pag. 28



NEW TR08

Pag. 71



NEW SOFTBAGS SERIES / SL

Pag. 80



NEW SW80

Pag. 86



SHAD
TERRA
 ENGINEERED FOR RIDING



TERRA LOCK SYSTEM PATENTED

INTEGRATED CARRYING HANDLE AND AISI 04 STAINLESS STEEL LOCK SYSTEM FOR ALUMINIUM CASES



TOP & SIDE OPENING

QUICK AND EASY ACCESS TO STORE YOUR BELONGINGS



SPR PRICE LIST

CAPACITY

DIFFERENT SIZE OPTIONS (UP TO 2 HELMETS) TO FIT YOUR TRAVEL NEEDS



DIFFERENT VERSIONS

DIFFERENT MATERIALS AND COLOURS FOR ANY SITUATION



SET **TR55 / 36 / 47** ALUMINIUM CASES



TR55

ALUMINIUM CASES

X57 Y41,8 Z32,2 cm
 ■ Pure Black painted Ref.D0TR55200B
 ■ Black painted Ref.D0TR55100B
 ■ Silver natural Ref.D0TR55100



PATENTED

TR48

ALUMINIUM CASES

X49,5 Y41,8 Z32,2 cm
 ■ Black painted Ref.D0TR48100B
 ■ Silver natural Ref.D0TR48100



PATENTED



Pure Black

Black

Silver

Black

Silver



Icon descriptions Page 103



Icon descriptions Page 103



DETAILS

Extra cargo hooks



Stainless steel hinges



Premium key antidust protector



Included inner mat



TERRA LOCK SYSTEM

Hardened aluminium alloy:
 Maximum resistance & minimum weight

AISI 304
 Stainless steel
 Integrated lock system

Integrated carrying handle



ACCESSORIES

BACKREST
 Ref. D0RI75



BRAKE LED LIGHT
 Ref. 201604



TR55 INNER BAG EXPANDABLE
 Ref. X0IB10



TR48 INNER BAG EXPANDABLE
 Ref. X0IB47



REQUIRED

OPTION 1
ALUMINIUM PLATE + SCREWS
 Ref. D1BTRPA



OPTION 2
ALUMINIUM PLATE + SCREWS
 Ref. D1BTRPA2



OPTION 3
BIG PLATE + SCREWS
 Ref. D1B591PA



TR46

X51,5 Y40,8 Z32 cm

■ Aluminium cover
Ref. D0TR46200

■ No cover
Ref. D0TR46100



No Cover

Aluminium Cover



Icon descriptions Page 103



INCLUDED

STANDARD PLATE + SCREWS



DETAILS

EXTRA CARGO

Possibility of adding additional load thanks to its external hooks.



ROBUST

Aisi 304 stainless steel lock system.



EXTRA RESISTANT

Reinforced structure in:



ACCESSORIES

BACKREST

Ref. D0RI46



INNER BAG

Ref. X0IB47



BRAKE LED LIGHT

Ref. D0B40KL



COLOUR COVERS

■ CARBON COVER
Ref. D1TR46E06

■ UNPAINTED COVER
Ref. D1TR46ER

TR41

X46,5 Y40,8 Z31,5 cm

■ Aluminium cover
Ref. D0TR41200

■ No cover
Ref. D0TR41100



No Cover

Aluminium Cover



Icon descriptions Page 103



INCLUDED

STANDARD PLATE + SCREWS



DETAILS

EXTRA CARGO

Possibility of adding additional load thanks to its external hooks.



ROBUST

Aisi 304 stainless steel lock system.



EXTRA RESISTANT

Reinforced structure in:



ACCESSORIES

BACKREST

Ref. D0RI41



BRAKE LED LIGHT

Ref. D0B40KL



COLOUR COVERS

■ CARBON COVER
Ref. D1TR41E06

■ UNPAINTED COVER
Ref. D1TR41ER

TR47

ALUMINIUM CASES

X49,5 Y41,8 Z34,5 cm

- Silver natural left Ref. D0TR47100L
- Silver natural right Ref. D0TR47100R
- Black painted left Ref. D0TR47100LB
- Black painted right Ref. D0TR47100RB

PATENTED

TR36

ALUMINIUM CASES

X49,5 Y41,8 Z28,2 cm

- Silver natural left Ref. D0TR36100L
- Silver natural right Ref. D0TR36100R
- Black painted left Ref. D0TR36100LB
- Black painted right Ref. D0TR36100RB

PATENTED



Left



Right



Icon descriptions Page 103

Left



Right



Icon descriptions Page 103



reddot winner 2021



DESIGN AWARD 2021



ABC SPECIAL MENTION 21

DETAILS

Stainless steel hinges



Premium key + antidust protector



Retractable folding tray



Side opening quick and easy access



Lock cylinders + keys (included in right case)



TERRA LOCK SYSTEM

Hardened aluminium alloy:
Maximum resistance & minimum weight

AISI 304
Stainless steel
Integrated lock system

Integrated carrying handle

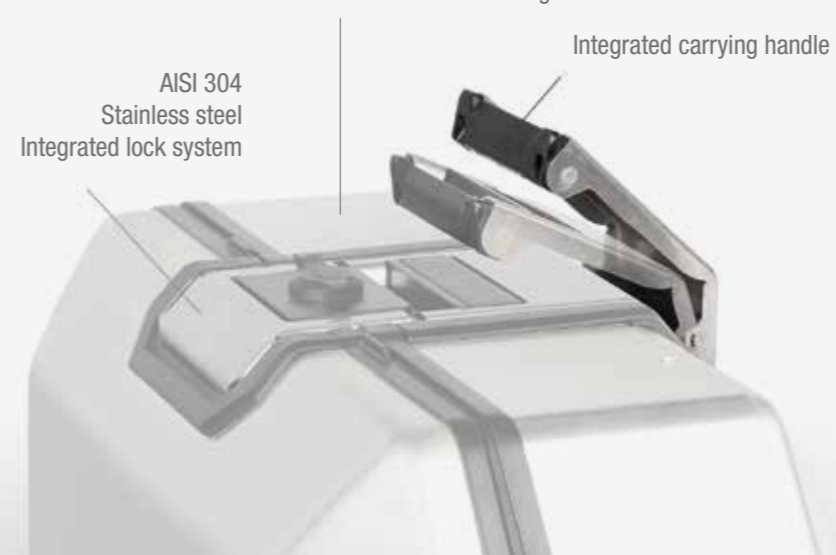

ACCESSORIES



LEFT



RIGHT

LOCK CYLINDERS + KEYS

For top, left & right case
Ref. D1TRB0R



NOT INCLUDED

INCLUDED

INNER MESH

Ref. X0TR01



NOT INCLUDED

INCLUDED

INNER BAG

Ref. X0IB47



NOT INCLUDED

NOT INCLUDED

REQUIRED



WATCH OUT EXHAUST PIPE SIDE
Recommended TR36

TR27

X50 Y28 Z34 cm
■ Aluminium cover Ref. D0TR27200
■ No cover Ref. D0TR27100



No cover

Aluminium



Icon descriptions Page 103



INCLUDED
EXTRA LOCK FOR YOUR TOP CASE



DETAILS

EXTRA CARGO
Possibility of adding additional load thanks to its external hooks.



OPENING ON THE TOP
Easy access to the inside.



RESISTANT
Up to 7kg of luggage.



ACCESSORIES

INNER BAG
Ref. X0IB27



COLOUR COVERS
CARBON COVER
Ref. D1TR27E06

UNPAINTED COVER
Ref. D1TR27ER

4P FITTING ADAPTER
Ref. D1TR27FIR



REQUIRED

OPTION 1



OPTION 2



TOP CASES



SET NEW SH51 TOP CASE / SH38X EXPANDABLE SIDE CASES

EXPANDABLE SYSTEM

PATENTED

PIONEERS IN EXPANDIBILITY, THE SH59X AND SH58X ARE THE ONLY EXPANDABLE TOP CASES IN THE AFTERMARKET.

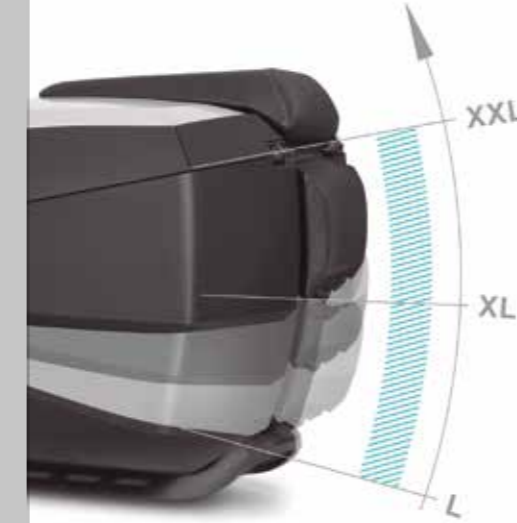

MOUNTING PLATE INCLUDED

ALUMINIUM AND PLASTIC PLATES WITH DIFFERENT FINISHES TO INCREASE THE PERFORMANCE OF MOTOR CASES



CAPACITY

DIFFERENT SIZE OPTIONS (UP TO 2 HELMETS) TO FIT YOUR TRAVEL NEEDS



SPECIFIC TOP MASTERS

SPECIFIC DEVELOPMENTS FOR EACH MOTORCYCLE TO IMPROVE THE EFFICIENCY OF SHAD TOP CASES



SH59X

X48 Y61 Z27/29/31.5 cm
Ref. D0B59200

PATENTED



EXPANDABLE CASE MAXIMUM VERSATILITY



Icon descriptions Page 103



INCLUDED

STANDARD PLATE + SCREWS



PREMIUM SMART LOCK



ACCESSORIES

BACKREST
Ref. D0RI80



INNER BAG
Ref. X0IB59



X 21/28 Y 50 Z 39 cm
EXPANDABLE

BRAKE LED LIGHT
Ref. 201604



ALUMINIUM PLATE + SCREWS
Ref. D1BTRPA



ALUMINIUM PLATE + SCREWS
Ref. D1BTRPA2



SH58X

X48 Y61 Z27/29/31.5 cm
Ref. D0B58206

PATENTED



EXPANDABLE CASE MAXIMUM VERSATILITY



Icon descriptions Page 103



INCLUDED

STANDARD PLATE + SCREWS



PREMIUM SMART LOCK



INCLUDED FREE COVER CARBON LOOK

ACCESSORIES

BACKREST
Ref. D0RI80



INNER BAG
Ref. X0IB59



BRAKE LED LIGHT
Ref. 201604



X 21/28 Y 50 Z 39 cm
EXPANDABLE

ALUMINIUM PLATE + SCREWS
Ref. D1BTRPA



ALUMINIUM PLATE + SCREWS
Ref. D1BTRPA2



COLOUR COVERS



NEW TITANIUM
Ref. D1B58E15



WHITE
Ref. D1B58E08



BLACK METAL
Ref. D1B58E21

NEW

SH51

X59 Y45,5 Z30 cm
Ref. D0B51200



Icon descriptions Page 103

INCLUDED

STANDARD PLATE + SCREWS



PREMIUM SMART LOCK



INNER MESH



ACCESSORIES

BACKREST
Ref. D0RI75



INNER BAG
Ref. X0IB10
X 35 Y 50 Z 21 cm



BRAKE LED LIGHT
Ref. 201604



WHITE REFLECTOR
Ref. D1B512CAR



RED REFLECTOR
Ref. D1B511CAR



ALUMINIUM PLATE + SCREWS
Ref. D1BTRPA



ALUMINIUM PLATE + SCREWS
Ref. D1BTRPA2



NEW

SH51

X59 Y45,5 Z30 cm
Ref. D0B51106



Icon descriptions Page 103

INCLUDED

STANDARD PLATE + SCREWS



PREMIUM SMART LOCK



INNER MESH



ACCESSORIES

BACKREST
Ref. D0RI75



INNER BAG
Ref. X0IB10
X 35 Y 50 Z 21 cm



BRAKE LED LIGHT
Ref. 201604



WHITE REFLECTOR
Ref. D1B512CAR



BLACK REFLECTOR
Ref. D1B51CAR



ALUMINIUM PLATE + SCREWS
Ref. D1BTRPA



ALUMINIUM PLATE + SCREWS
Ref. D1BTRPA2



COLOUR COVER
UNPAINTED COVER
Ref. D1B51ER



SH48

X46 Y61 Z31 cm
■ New Titanium
Ref. D0B48406R

■ Dark grey
Ref. D0B48306R



New Titanium

Dark Grey



ACCESSORIES

BACKREST
Ref. D0RI4800



INNER BAG
Ref. X0IB00



X 35 Y 50 Z 21 cm

LUGGAGE RACK
Ref. D0PS00



BRAKE LED LIGHT
Ref. 201604



**ALUMINIUM
PLATE + SCREWS**
Ref. D1BTRPA



**ALUMINIUM
PLATE + SCREWS**
Ref. D1BTRPA2



COLOUR COVERS

● **WHITE**
Ref. D1B48E08

● **CARBON**
Ref. D1B48E06

● **NEW TITANIUM**
Ref. D1B48E15

● **DARK GREY**
Ref. D1B48E17

NO COVER TOP CASE
Dark Grey
Ref. D0B48300
New Titanium
Ref. D0B48400

**CARBON + BACKREST
TOP CASE**
Dark Grey
Ref. D0B48306R
New Titanium
Ref. D0B48406R

INCLUDED

STANDARD PLATE + SCREWS



PREMIUM SMART LOCK



SH47

X42 Y57,5 Z31,2 cm
■ Red Ref. D0B47206 □ White Ref. D0B47106



ACCESSORIES

INNER BAG
Ref. X0IB00



X 35 Y 50 Z 21 cm

BACKREST
Ref. D0RI47



BRAKE LED LIGHT
Ref. D0B40KL



COLOUR COVERS

● **WHITE**
Ref. D1B47E08

● **NEW TITANIUM**
Ref. D1B47E15

● **UNPAINTED
COVER**
Ref. D1B47ER

INCLUDED

STANDARD PLATE + SCREWS



Icon descriptions Page 103



Icon descriptions Page 103

SH46

X42 Y58 Z31 cm
Ref. D0B46200



Icon descriptions Page 103

INCLUDED

STANDARD PLATE + SCREWS



ACCESSORIES

BACKREST
Ref. D0RI50



INNER BAG
Ref. X0IB00
X 35 Y 50 Z 21 cm



LUGGAGE RACK
Ref. D0PS00



BRAKE LED LIGHT
Ref. D0B40KL



SH45

X41 Y56.4 Z31.4 cm
Ref. D0B45100



Icon descriptions Page 103

INCLUDED

STANDARD PLATE + SCREWS



ACCESSORIES

BACKREST
Ref. D0RI60



INNER BAG
Ref. X0IB00
X 35 Y 50 Z 21 cm



BRAKE LED LIGHT
Ref. D0B40KL



COLOUR COVERS

BLUE
Ref. D1B45E01

SILVER
Ref. D1B45E05

WHITE
Ref. D1B45E08

BLACK
Ref. D1B45E21

SH44

X43,5 Y55 Z31,5 cm
Ref. D0B44100



Icon descriptions Page 103

INCLUDED

STANDARD PLATE + SCREWS



ACCESSORIES

BACKREST
Ref. D0RI60



BRAKE LED LIGHT
Ref. D0B40KL



INNER BAG
Ref. X0IB00
X 35 Y 50 Z 21 cm



SH40

X42,5 Y49,5 Z29,6 cm
■ Ref. D0B40100

■ Alu look
Ref. D0B40200



Icon descriptions Page 103

INCLUDED

STANDARD PLATE + SCREWS



ACCESSORIES

BACKREST
Ref. D0RI60



BRAKE LED LIGHT
Ref. D0B40KL



COLOUR COVERS

BLACK
Ref. D1B40E21

WHITE
Ref. D1B40E08

SH40

CARGO



X42.5 Y49.2 Z32.5 cm
Ref. D0B40199



Icon descriptions Page 103

INCLUDED

STANDARD PLATE + SCREWS



TOP PANNIER RACK



ACCESSORIES

BACKREST
Ref. D0RI60



BRAKE LED LIGHT
Ref. D0B40KL



SH39

X43 Y51 Z32 cm
Carbon cover Ref. D0B39106



Icon descriptions Page 103

INCLUDED

STANDARD PLATE + SCREWS



ACCESSORIES

BACKREST
Ref. D0RI3900



BRAKE LED LIGHT
Ref. D0B40KL



COLOUR COVERS

WHITE
Ref. D1B39E08

NEW TITANIUM
Ref. D1B39E15

BLACK
Ref. D1B39E21

UNPAINTED COVER
Ref. D1B39ER

NO COVER TOP CASE
Ref. D0B39100

SH34

X42 Y43 Z31 cm
Ref. D0B34106



Icon descriptions Page 103

INCLUDED

STANDARD PLATE + SCREWS



INCLUDED
FREE COVER
CARBON LOOK

ACCESSORIES

BACKREST
Ref. D0RI40



BRAKE LED LIGHT
Ref. 201604



SH33

X42 Y43 Z31 cm
Ref. D0B33200

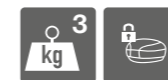

Icon descriptions Page 103

INCLUDED

STANDARD PLATE + SCREWS



ACCESSORIES

BACKREST
Ref. D0RI40





BRAKE LED LIGHT
Ref. 201604



COLOUR COVERS

 **WHITE**
Ref. D1B33E808

 **BLACK**
Ref. D1B33E821

 **UNPAINTED COVER**
Ref. D1B33E800

SH29

X38 Y40 Z30 cm
Ref. D0B29100



Icon descriptions Page 103

INCLUDED

STANDARD PLATE + SCREWS



ACCESSORIES

BACKREST

Ref. D0RI40



BRAKE LED LIGHT

Ref. 201604



COLOUR COVERS



WHITE

Ref. D1B29E08



RED

Ref. D1B29E09



BLACK

Ref. D1B29E21



UNPAINTED COVER

Ref. D1B29ER

SH26

X40.5 Y40 Z28.2 cm
Ref. D0B26100



Icon descriptions Page 103

INCLUDED

STANDARD PLATE + SCREWS



ACCESSORIES

BRAKE LED LIGHT

Ref. 201604



SIDE CASES



SH38X EXPANDABLE SIDE CASES

EXPANDABLE SYSTEM

PATENTED

PIONEERS IN EXPANDIBILITY, THE SH38X ARE THE ONLY EXPANDABLE SIDE CASES IN THE AFTERMARKET.



INTEGRATION

THE SPECIFIC DEVELOPMENTS OF 3P SYSTEM (PATENTED) FOR EACH MOTORCYCLE ALLOW TO OPTIMIZE INTEGRATION & PERFORMANCE.



CAPACITY

SIDE CASES WITH A CAPACITY UP TO A MODULAR HELMET.



4P SYSTEM



3P SYSTEM



3P & 4P SYSTEM SIDE FITTINGS

DIFFERENTS FITTING KITS. THE 3P SYSTEM ALLOWS A SOLID MOUNTING WITH JUST 3 ANCHOR POINTS.



PIONEERS IN EXPANDABILITY

SH38X is the only expandable side case in the aftermarket. A telescopically expandable case that works thanks to an innovative system called DYNAMIC TENSEGRITY

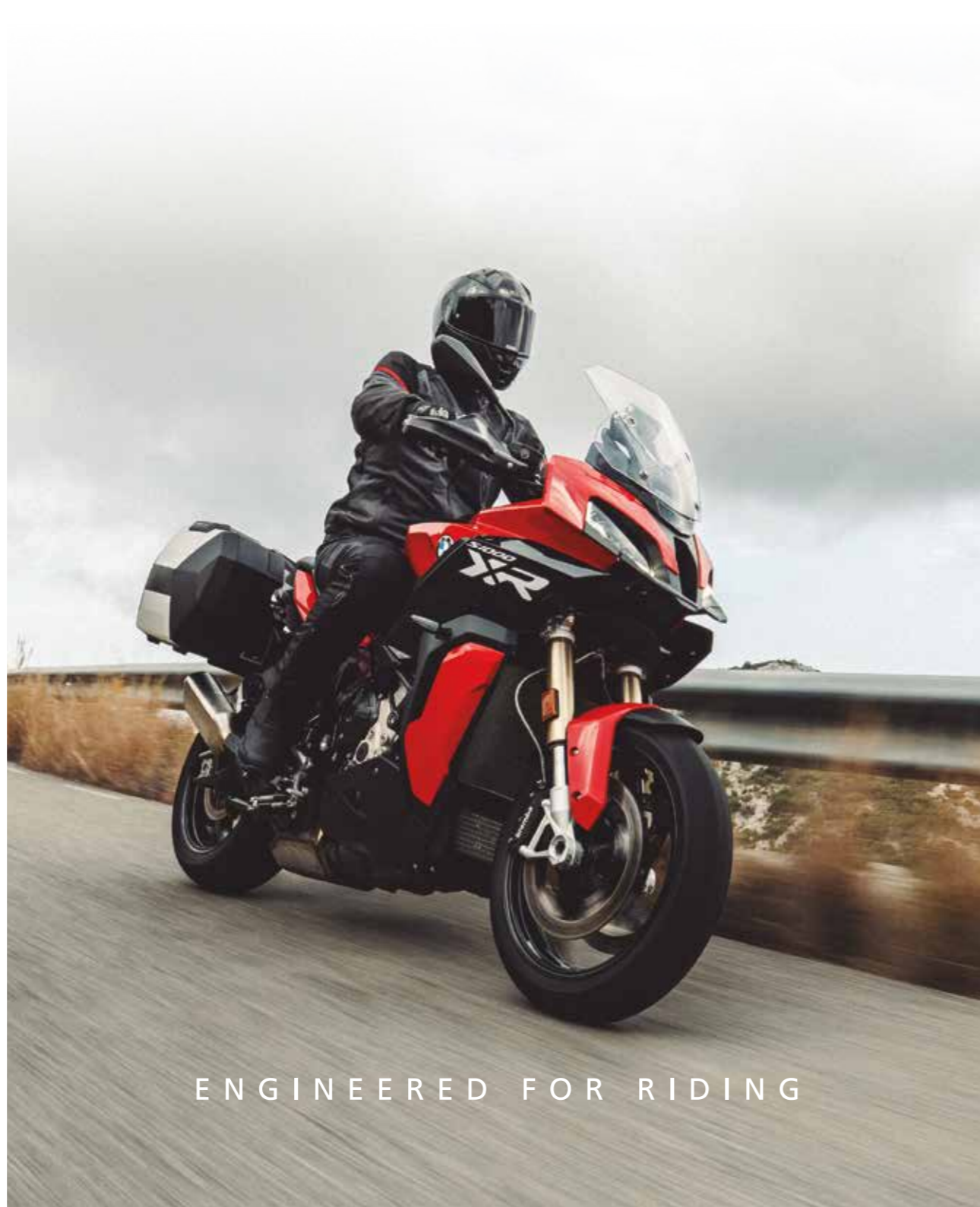

ENGINEERED FOR RIDING

INSPIRATION & DESIGN PROCESS

TENSEGRITY is a form of construction that uses rigid elements interconnected by tensioned cables or ropes to create strong, flexible, and adaptable structures.

It is used in structural engineering, architecture, and mechanical systems design. In nature we find it in the human body within the bone structure, the muscular system, the connective tissue, as well as spider webs, bird nests and fern leaves.

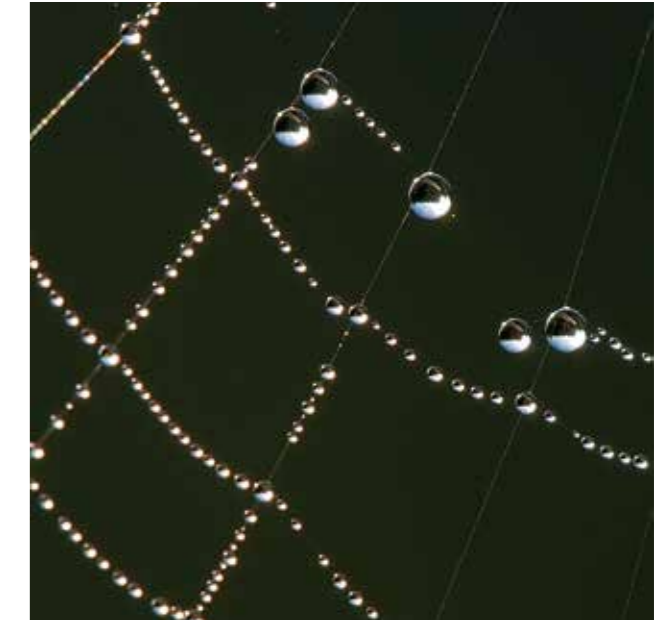

De I, Luc Viatour, CCB BY-SA 3.0, <https://commons.wikimedia.org/w/index.php?curid=3626879>

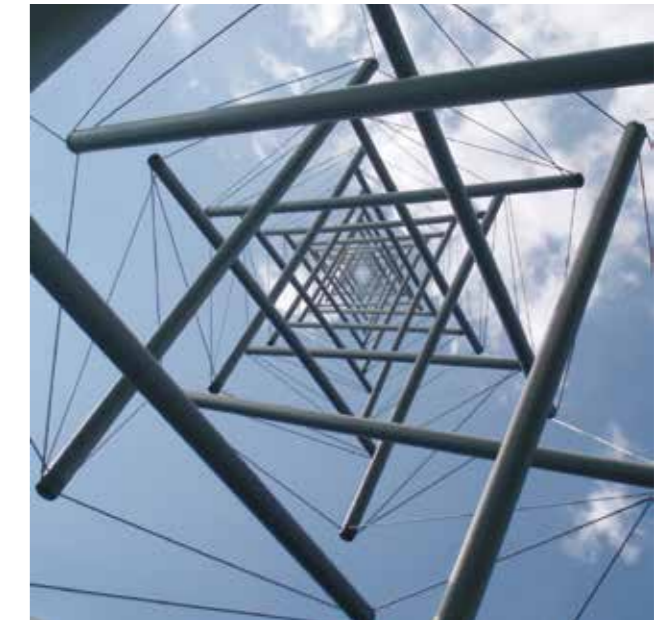

De Onderwijsgek - Trabajo propio, CC BY-SA 2.5 nl, <https://commons.wikimedia.org/w/index.php?curid=2120206>

HOW IT WORKS

SHAD developed a tension cable system with 4 incorporated guides inside of the case's frame. The expansion and contraction movement is transferred uniformly in all the mechanism. This allows a smooth and uniform expansion SYSTEM



ENGINEERED FOR RIDING

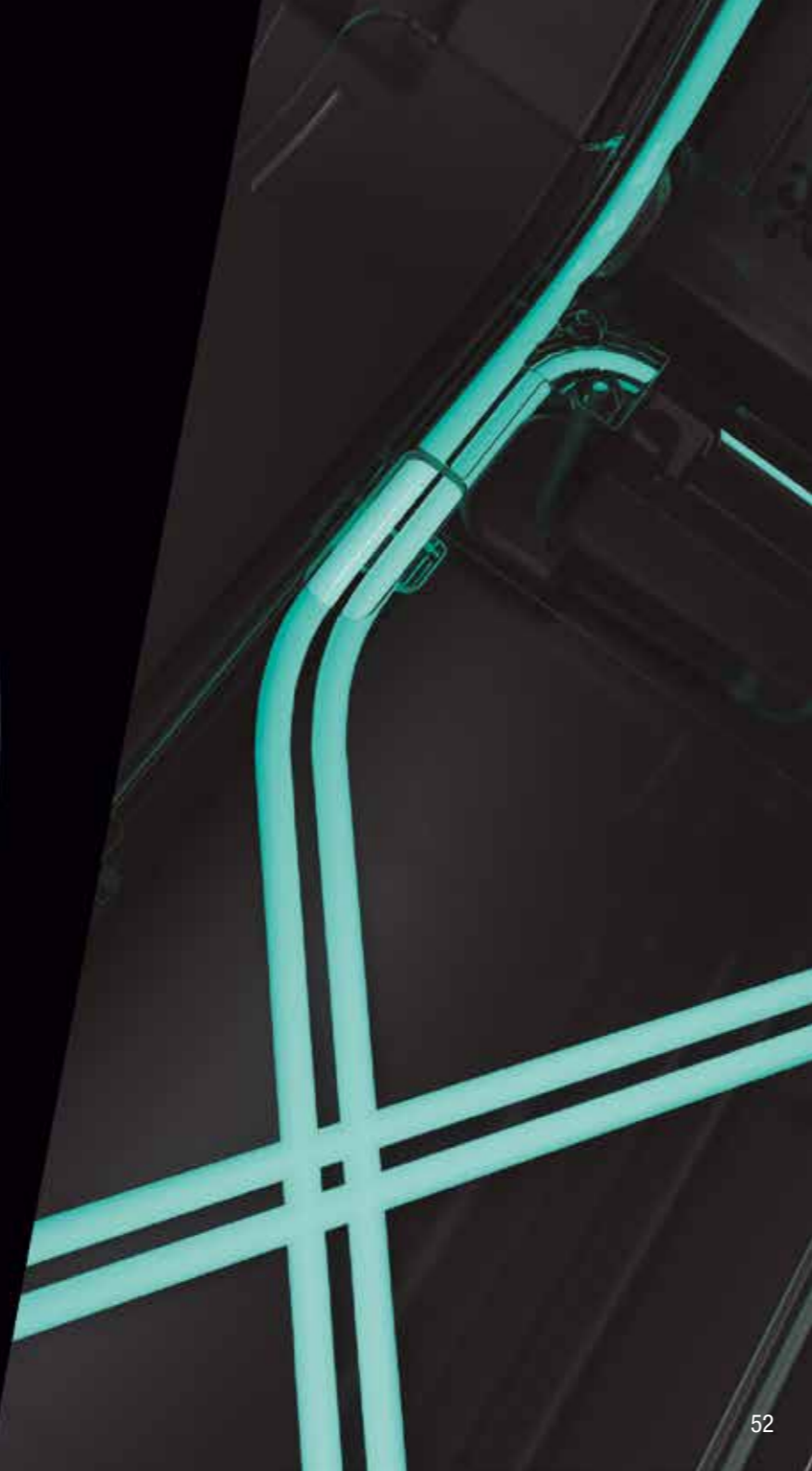

MODULAR HELMET 1 CAPACITY

EXPANDABILITY 40%

10 kg EXPANDED 40% 4P SYSTEM 3P SYSTEM

SH38X / EXPANDABLE

X51 Y27/34 Z39 cm
Ref. D0B38200

PATENTED

DETAILS

EXPANDABILITY / 40%



ERGONOMY Retractable and integrated carrying handle



PREMIUM LOCK 1 hand use



INNER TRAY



ACCESSORIES

EXPANDABLE INNER BAG Ref. X0IB38



4P FITTING ADAPTER Ref. 204632R



REQUIRED

OPTION 1



OPTION 2



Icon descriptions Page 103



reddot winner 2024



AD2 Awards 2024

INCLUDED

EXTRA LOCK FOR YOUR TOP CASE



INNER MESH



SH38X CARBON / EXPANDABLE

X51 Y27/34 Z39 cm
Ref. D0B38106

PATENTED

DETAILS

EXPANDABILITY / 40%



ERGONOMY Retractable and integrated carrying handle



PREMIUM LOCK 1 hand use



INNER TRAY



ACCESSORIES

EXPANDABLE INNER BAG Ref. X0IB38



4P FITTING ADAPTER Ref. 204632R



COLOUR COVERS

WHITE Ref. D1B38E08

BLACK Ref. D1B38E21

UNPAINTED COVER Ref. D1B38ER



Icon descriptions Page 103



reddot winner 2024



AD2 Awards 2024

INCLUDED

EXTRA LOCK FOR YOUR TOP CASE



INNER MESH



INCLUDED FREE COVER CARBON LOCK

REQUIRED

OPTION 1



OPTION 2



SH36

X51 Y33 Z38 cm
Ref. D0B36200



Icon descriptions Page 103

INCLUDED

EXTRA LOCK FOR YOUR TOP CASE



DETAILS

RETRACTABLE HANDLE



PREMIUM LOCK
1 hand use



ELASTIC STRAP



INNER TRAY



ACCESSORIES

INNER BAG
Ref. X0IB36
X 28 Y 41 Z 31 cm



RED REFLECTOR
Ref. D1B36CAR



COLOUR COVERS

WHITE
Ref. D1B36E08

NEW TITANIUM
Ref. D1B36E15

REQUIRED

OPTION 1



OPTION 2



SH35

X51 Y30 Z38 cm
Ref. D0B35200



Icon descriptions Page 103

INCLUDED

EXTRA LOCK FOR YOUR TOP CASE



DETAILS

RETRACTABLE HANDLE



PREMIUM LOCK
1 hand use



ELASTIC STRAP



INNER TRAY



ACCESSORIES

INNER BAG
Ref. X0IB36
X 28 Y 41 Z 31 cm



REQUIRED

OPTION 1



OPTION 2



SH23



X49 Y26 Z35 cm
 ■ Black Ref. D0B23100 ■ Alu Look Ref. D0B23200W



Black

Aluminium Cover

COLOUR COVERS

-  **WHITE**
Ref. D1B23E08
-  **NEW TITANIUM**
Ref. D1B23E15
-  **UNPAINTED COVER**
Ref. D1B23ER

REQUIRED

OPTION 1



OPTION 2



INCLUDED

EXTRA LOCK FOR YOUR TOP CASE



ACCESSORIES

4P FITTING ADAPTER
 Ref. D1TR27FIR



ACCESSORIES FOR MOTOR CASES

INNER BAGS

TR48/TR47/TR46/TR36 **EXPANDABLE**
 X47 Y33 Z17 cm
 Ref. X0IB47



SH38X **EXPANDABLE**
 X21 Y26,5 Z37 cm
 Ref. X0IB38



SH48 / SH47 / SH46 /
 SH45 / SH44
 X30 Y50 Z21 cm
 Ref. X0IB00



SH59X / SH58X
 X21/28 Y50 Z39 cm
 Ref. X0IB59



TR55 / SH51 **EXPANDABLE**
 X51,5 Y34,5 Z17/21 cm
 X0IB10



TR27
 X21 Y26,5 Z37 cm
 Ref. X0IB27



SH36/SH35
 X41,5 Y26,5 Z25 cm
 Ref. X0IB36



TOP CASES

	Backrest	Inner bags	Upper rack	Brake lights	Colour covers
TR55	D0RI75	X0IB10		D0B29KL	
TR48/TR48B	D0RI75	X0IB47		D0B29KL	
TR46	D0RI46	X0IB47		D0B40KL	● ●
TR41	D0RI41			D0B40KL	● ●
SH59X	D0RI80	X0IB59		D0B29KL	
SH58X	D0RI80	X0IB59		D0B29KL	● ●
SH51	D0RI75	X0IB10		D0B29KL	●
SH48	D0RI4800	X0IB00	D0PS00	D0B29KL	● ● ● ●
SH47	D0RI47	X0IB00		D0B40KL	● ● ●
SH46	D0RI50	X0IB00	D0PS00	D0B40KL	● ● ● ●
SH45	D0RI60	X0IB00		D0B40KL	● ● ● ●
SH44	D0RI60	X0IB00		D0B40KL	● ● ● ●
SH40	D0RI60			D0B40KL	● ● ● ●
SH40 CARGO	D0RI60			D0B40KL	● ● ● ●
SH39	D0RI3900			D0B40KL	● ● ● ●
SH34	D0RI40			D0B29KL	● ● ● ●
SH33	D0RI40			D0B29KL	● ● ● ●
SH29	D0RI40			D0B29KL	● ● ● ●
SH26				D0B29KL	● ● ● ●

SIDE CASES

	Inner bags	Inner mesh	Colour Covers
TR47/TR47B	X0IB47	X0TR01	
TR36/TR36B	X0IB47	X0TR01	
TR27	X0IB27		● ●
SH38X	X0BI38		● ● ● ●
SH36	X0IB36		● ● ● ●
SH35	X0IB36		● ● ● ●
SH23			● ● ● ●

- Blue ● Silver ● Carbon ● White ● Red
- New titanium ● Black ● Dark Grey ● Unpainted color



Icon descriptions Page 103

FITTING KITS



SET NEW SH51 TOPCASE / SH38X EXPANDABLE SIDE CASE

FITTING KIT / 4P & 3P SIDE CASES



4P
SYSTEM



DURABILITY

Designed for hard use. Transversal support to increase strength between the two cases.

MATERIAL

20mm Steel frame. Biggest in the market. Metallic powder coated paint.

COMPATIBLE WITH:

TR47L & TR47R, TR47L & TR47R BLACK EDITION, TR36L & TR36R, TR36L & TR36R BLACK EDITION, SH38X, SH36, SH35, SH23, TR40, TR30, TR27.



PATENTED

3P
SYSTEM



INTEGRATED DESIGN

The 3P System is the almost invisible side cases and bags fitting. It integrates its aesthetic into the motorcycle and allows a solid mounting with just 3 anchor points.

LIGHTNESS

Nearly no change in the bike's center of gravity, hence improving safety.

MATERIAL

20mm Steel frame. Biggest in the market. Metallic powder coated paint.

PATENTED

3 point to fit the case on the bike.

COMPATIBLE WITH:

SH38X, SH36, SH35, SH23, TR40, TR30, TR27.

TOP FITTING / TOP CASES



SIDE BAG HOLDER / SADDLEBAGS

SIDE BAG HOLDER:
SL58/E48



UNIVERSAL SIDE HOLDER
SL58/E48
Ref. D0SS5SE



SIDE BAG HOLDER SR:
E48SR/SR38

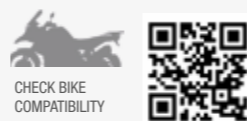

MOUNTING PLATES FOR TOP FITTING

S SMALL PLATE



INCLUDED
SH26/SH29/SH33/SH34
Ref. D1B29PAR

M MEDIUM PLATE



INCLUDED
SH39/SH40/SH44/SH45/
SH46/SH47/TR41/TR46
Ref. D1B40PAR

B BIG PLATE



INCLUDED
SH59X/SH58X/
SH51/SH48

NOT INCLUDED
TR55/TR48/TR50
Ref. D1B591PA

A ALUMINIUM PLATES



NOT INCLUDED
SH59X/SH58X/
SH51/SH48/TR55/
TR50/TR48
Aluminium Plate.-
D1BTRPA
Black Aluminium
Plate.- D1BTRPA2

CLICK SYSTEM TANK BAGS



MOUNT



DISMOUNT



Release button

CLICK SYSTEM

ENGINEERED FOR RIDING



BACKRESTS

SCOOTER

HOW TO BUY

STEP 1: FITTING KIT

Look for your motorcycle model



STEP 2: BACKREST

Choose your favorite color

Ref. D0RP00



Ref. D0RP08



Ref. D0RP05



Ref. D0RP10N



CUSTOM Sissybar

HOW TO BUY

STEP 1: BACKREST

Look for your motorcycle model



STEP 2: RACK

Choose top case Rack



CHROMED
Ref. NADTN



BLACK
Ref. NADTNN



COMFORT SEATS

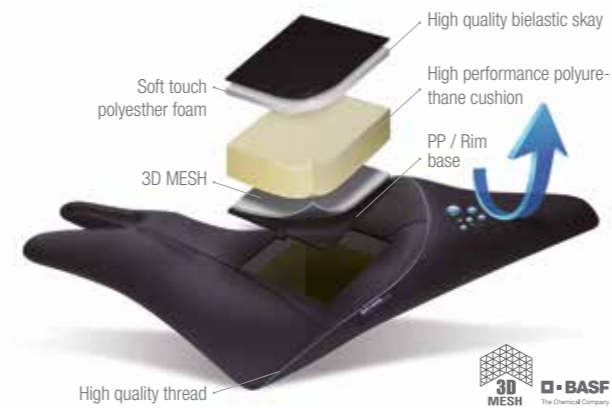

High quality bielastic skay
Resistant to:



KAWASAKI Z750-1000

Z750 (2007-13) · Z1000 (2007-09)
Black, with dark, grey seams
Ref. SHK0Z1000C



PIAGGIO MP3

MP3 RL (2007-12) · MP3 RST 125-250-100 (2009-12) · MP3
LT 250-400 (2009-13) · MP3 500 SPORT/BUSINESS (2011-13)
Black-white, grey-blue seams
Ref. SHV0M2320



YAMAHA T-MAX

T-MAX 500 (2008-13) · T-MAX 530 (2014-16)
Black, with white seams
Ref. SHY0T5320



YAMAHA FZ6

FAZER FZ6 600 (2004-10)
Black, with grey seams
Ref. SHY0F7000



YAMAHA MT-09

MT-09 (2013-18)
Black-grey, with grey seams
Ref. SHY0M9300



BAGS



E48SR HARD SHELL SADDLE BAGS

TERRA
ADVENTURE BAGS



TERRA | WATERPROOF
ADVENTURE BAGS



SPORT
EVA SEMIRIGID BAGS



SPORT
ABS SEMIRIGID BAGS



CAFE RACER
GENUINE BAGS



SL
SOFT BAGS



SW | WATERPROOF
WELDED BAGS



TR40

X40 Y25 Z38 cm
Ref. X0TR402

PATENTED

TERRA ADVENTURE SADDLEBAGS SET X 2



Icon descriptions Page 103



INCLUDED

DRY BAG + BAG HOLDER



FUEL BOTTLE HARNESS



PREMIUM LOCK
+ ANTIDUST PROTECTOR



DETAILS

ADJUST THE BAG TO THE SIZE OF THE LOAD
4 Side + 2 top cambuckles



DOUBLE LOCKING SYSTEM
Quick mounting & quick locking: one key to open and release. Lock access to inside of the bag



WATERPROOF
Double roll bags: outer bag and included inner bag ensures waterproofness



2 MOLLE SYSTEM GRIDS PER BAG



AIRCRAFT GRADE ANODIZED ALUMINUM BUCKLES



REFLECTIVE ELEMENTS



ULTRA DURABLE MATERIAL

- 1500h UV protection
- Abrasion resistance **50.000 cycles**

- Reinforced stitching
- Reinforced bottom structure

ACCESSORIES



CRASH BAR BAG
Ref. X0TR08



EXTENSION STRAPS
Ref. X1TR09

REQUIRED

OPTION 1



OPTION 2



TR30 | WATERPROOF

X40 Y23 Z38 cm
Ref. X0TR30

PATENTED

TERRA ADVENTURE SADDLEBAGS SET X 2



Icon descriptions Page 103

INCLUDED

PREMIUM LOCK
+ ANTIDUST PROTECTOR



DETAILS

ADJUST THE BAG TO THE SIZE OF THE LOAD
4 Side + 2 top buckles



DOUBLE LOCKING SYSTEM
Quick mounting & quick locking: one key to open and release. Lock access to inside of the bag



WATERPROOF
Double roll bags



AIRCRAFT GRADE ANODIZED ALUMINUM BUCKLES



REFLECTIVE ELEMENTS



ULTRA DURABLE MATERIAL

- 1000h UV protection
- Abrasion resistance **25.000 cycles**
- Ultra high frequency holding
- Reinforced bottom structure

ACCESSORIES



EXTENSION STRAPS
Ref. X1TR09

REQUIRED

OPTION 1



OPTION 2



TR50

TEXTILE TOP CASE

X35 Y57 Z31,5 cm
Ref. X0TR50



Icon descriptions Page 103



INCLUDED

SHOULDER STRAP



RAIN COVER



PREMIUM LOCK
+ ANTIDUST PROTECTOR



DETAILS

2 MOLLE SYSTEM
GRIDS



ULTRA DURABLE
MATERIAL

DRY BAG + BAG HOLDER
Ref. X1TR03



REFLECTIVE
ELEMENTS



- 1000h UV protection
- Reinforced stitching
- Reinforced bottom structure

ACCESSORIES

BOTTLE HARNESS
Ref. X1TR05



INSTALLATION ON
A PLATE



CRASH BAR BAG
Ref. X0TR08



REQUIRED

OPTION 1
ALUMINIUM PLATE + SCREWS
Ref. D1BTRPA



OPTION 2
ALUMINIUM PLATE + SCREWS
Ref. D1BTRPA2



OPTION 3
BIG PLATE + SCREWS
Ref. D1B591PA



NEW

TR08 | WATERPROOF

CRASH BAR BAG
1 UN

X22 Y28 Z13 cm
Ref. X0TR08



Icon descriptions Page 103

DETAILS

WATERPROOF
Double Roll Bag



CAPACITY
2,6 kg maximum load



ADJUST THE BAG TO
THE SIZE OF THE LOAD
3 Compression straps



REFLECTIVE ELEMENTS



DOUBLE LOCKING SYSTEM



ULTRA DURABLE MATERIAL
• 1500h UV resistance

ACCESSORIES

FILM PROTECTOR
Ref. X1SL02

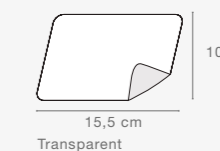

CLICK SYSTEM

TANK BAGS



Icon descriptions Page 103

HOW TO BUY

STEP 1. CHOOSE YOUR TANK BAG

- SPORT SEMIRIGID EVA
- SPORT SEMIRIGID ABS
- TERRA
- TERRA WATERPROOF



STEP 2: CLICK SYSTEM FITTING KIT



TERRA ADVENTURE

TR15



*

TR10



* TR15 can reach Double Security thanks to its padlock zipper.

SPORT / TOURING

E03CL PRO



E09CL PRO



E03C



*

E09CLD



E02



*

E09CM



*

DOUBLE SECURITY



* It's required to buy separately, reference X1SESTLR and X1SESTCL

E09C



*

INCLUDED
RING INCLUDED WITH THE BAG



REQUIRED
CLICK SYSTEM FITTING KIT



CHECK BIKE COMPATIBILITY



DOUBLE SECURITY SYSTEM

LOCKING MECHANISM

COMBINATION LOCK



TR15

ADVENTURE CLICK
SYSTEM TANK BAG

X38 Y29 Z23 cm
Ref. X0TR15CL



Icon descriptions Page 103

INCLUDED



DETAILS

PADLOCK ZIPPERS
Padlock not included



PUSH BUTTON
Release system



REFLECTIVE ELEMENTS



ADJUSTABLE
to tank's shape



ULTRA DURABLE MATERIAL

- 1000h UV protection
- Polyester 900D, PVC coating
- PU + Hypalon.

ACCESSORIES

FILM PROTECTOR
Ref. X1SL02



REQUIRED

CLICK SYSTEM FITTING KIT



TR10 | WATERPROOF

ADVENTURE CLICK
SYSTEM TANK BAG

X35 Y20 Z20 cm
Ref. X0TR10CL



Icon descriptions Page 103

INCLUDED



DETAILS



DRAIN HOLES



ULTRA DURABLE MATERIAL

- 1500h UV protection
- Polyester 600D, PVC TARPAULIN

ACCESSORIES

FILM PROTECTOR
Ref. X1SL02



REQUIRED

CLICK SYSTEM FITTING KIT



CLICK SYSTEM TANK BAG E09

E09CL PRO

X 30 Y 24,5 Z 14/20 cm
Ref. X0SE09CLP



Icon descriptions Page 103

INCLUDED

DOUBLE SECURITY SYSTEM:
Combination Lock + Locking system



DETAILS

EXPANDABLE

SMARTPHONE HOLDER



E09CLD

X 30 Y 24,5 Z 14 cm
Ref. X0SE09CLD



Icon descriptions Page 103

INCLUDED

DOUBLE SECURITY SYSTEM:
Combination Lock + Locking system



E09c

X 30 Y 24,5 Z 14 cm
Ref. X0SE09C



Icon descriptions Page 103

ACCESSORIES

DOUBLE SECURITY SYSTEM:

COMBINATION LOCK
Ref. X1SESTCL



LOCKING SYSTEM
Ref. X1SESTLR



E09CM

X 30 Y 24,5 Z 14 cm
Ref. X0SE09CM



Icon descriptions Page 103

ACCESSORIES

DOUBLE SECURITY SYSTEM:

COMBINATION LOCK
Ref. X1SESTCL

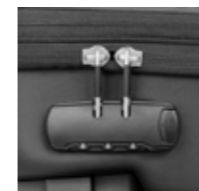

LOCKING SYSTEM
Ref. X1SESTLR



INCLUDED

CLICK SYSTEM RING



RAIN COVER



SHOULDER STRAP



ACCESSORIES

FILM PROTECTOR
Ref. X1SL02



REQUIRED

CLICK SYSTEM FITTING KIT
+ SCREWS



E 09CM VS E 09

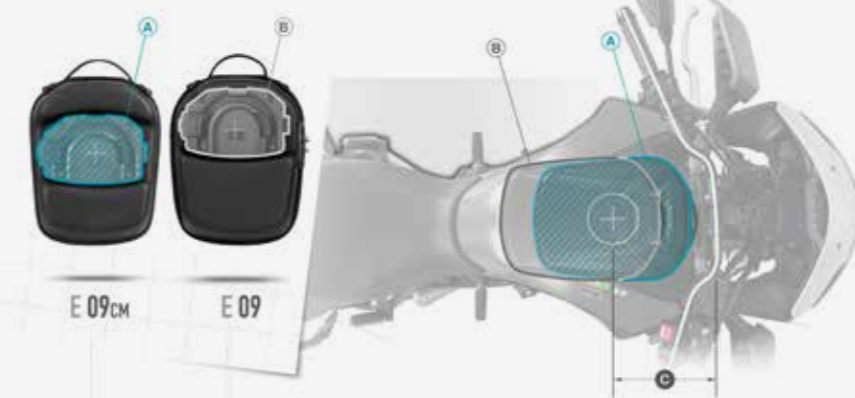

	C > 12 cm	12 cm > C > 8 cm	C < 8 cm
E 09 CM	✓ (recommended)	✗	✗
E 09	✓	✓	✗

CLICK SYSTEM TANK BAG E03 / E02

E03CL PRO

X 23 Y 21 Z 11/17 cm
Ref. X0SE03CLP



Icon descriptions Page 103

INCLUDED

COMBINATION
LOCK



LOCKING
MECHANISM



DETAILS



E03c

X 23 Y 21 Z 11 cm
Ref. X0SE03C



Icon descriptions Page 103

ACCESSORIES

DOUBLE SECURITY SYSTEM:

COMBINATION LOCK
Ref. X1SESTCL



LOCKING MECHANISM
Ref. X1SESTLR



E02

X 23 Y 21 Z 11 cm
Ref. X0SE02C



Icon descriptions Page 103

ACCESSORIES

DOUBLE SECURITY SYSTEM:

COMBINATION LOCK
Ref. X1SESTCL



LOCKING MECHANISM
Ref. X1SESTLR



INCLUDED

CLICK SYSTEM RING



RAIN COVER



SHOULDER STRAP



ACCESSORIES

FILM PROTECTOR
Ref. X1SL02



REQUIRED

CLICK SYSTEM FITTING KIT + SCREWS



E09 CLICK SYSTEM TANK BAG

NEW

SL58

X29 Y45 Z17/22 cm
Ref. X0SL581

EXPANDABLE
SADDLEBAGS
SET X 2



Icon descriptions Page 103

INCLUDED

VELCRO & SECURITY
STRAPS

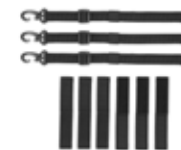

RAIN COVER



ACCESSORIES

THERMO PAD
Ref. X1SB97



NEW SL20F

X26 Y36 Z20/25 cm
Ref. X0SL201F

TANK BAG



Icon descriptions Page 103

INCLUDED

RAIN COVER



SECURITY STRAP



FITTING STRAPS



SHOULDER STRAPS x2



ACCESSORIES

UNIVERSAL BASE TANK
Ref. X1SL90



MAGNETS SYSTEM
Ref. X1SL11



FILM PROTECTOR
Ref. X1SL02



NEW

SL12M

X20 Y30 Z13 cm
Ref. X0SL121M

MAGNET TANK BAG



Icon descriptions Page 103

INCLUDED

RAIN COVER



SECURITY STRAP



SHOULDER STRAP



ACCESSORIES

FILM PROTECTOR
Ref. X1SL02



NEW SL86

X31 Y47 Z16 cm
Ref. X0SL861

BACKPACK



Icon descriptions Page 103

INCLUDED

RAIN COVER



DETAILS

PADDED
POUCH



SL05

BIG LEG BAG

X15 Y24 Z10 cm
Ref. X0SL051



Icon descriptions Page 103



INCLUDED



STRAP BELT

DETAILS

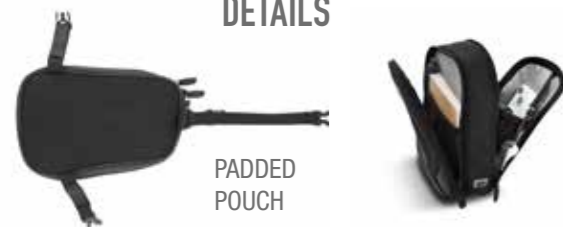

PADDED POUCH

NEW SL04

SMALL LEG BAG

X15 Y24 Z3 cm
Ref. X0SL041



Icon descriptions Page 103



INCLUDED



STRAP BELT

DETAILS

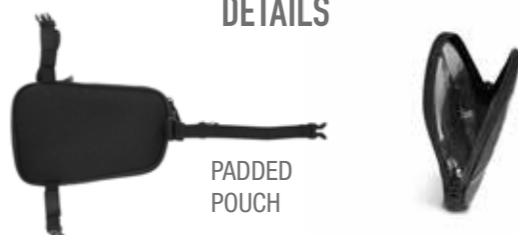

PADDED POUCH

NEW SL03

WAIST BAG

X18 Y25 Z9 cm
Ref. X0SL031



Icon descriptions Page 103

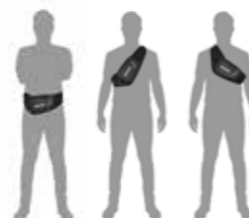

DETAILS



PADDED POUCH

SL01

TOLL PASS POUCH

X4 Y6 Z10 cm
Ref. X0SL01



SC25

SCOOTER BAG

X38 Y27 Z26 cm
Ref. X0SC25



Icon descriptions Page 103



DETAILS



E04

SMALL TANK BAG

X29 Y26 Z10 cm
Ref. X0SE04



Icon descriptions Page 103

INCLUDED

RAIN COVER



SECURITY STRAPS



ACCESSORY

MAGNETS (4U.)
Ref. X1SL11



UNIVERSAL
BASE TANK
Ref. X1SL90



FILM PROTECTOR
Ref. X1SL02



E48SR

HARDSHELL SADDLEBAGS SET X 2

X 45 Y 27 Z 29 cm
Ref. X0SE48SR



Icon descriptions Page 103

INCLUDED

INNER BAG



KEY LOCK MECHANISM



DETAILS

COMBINATION LOCK

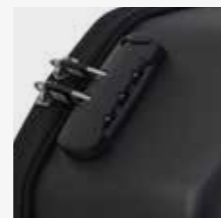

INTEGRATED CARRYING HANDLE



FITTING SYSTEM



REQUIRED

SIDE BAG HOLDER SR



E48

EXPANDABLE SADDLEBAGS SET X 2

X 47 Y 24/30 Z 29 cm
Ref. X0SE482



Icon descriptions Page 103

INCLUDED

FITTING POCKET



SECURITY STRAPS



RAIN COVER



ACCESSORIES

THERMO PAD
Ref. X1SB97



SR38

CAFE RACER SADDLEBAG 1 UN

X24 Y15 Z34 cm
■ Black Ref. X0SR3821
■ Brown Ref. X0SR38



Icon descriptions Page 103

INCLUDED

LOCKING MECHANISM

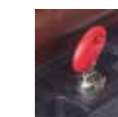

REQUIRED

SIDE BAG HOLDER SR



SW80 | WATERPROOF
REAR DUFFLE BAG

X70 Y35 Z31 (cm).
Ref. X0SW80



Icon descriptions Page 103



INCLUDED

FITTING STRAPS



DETAILS

WATERPROOF
Roll up closure



ADJUST THE VOLUME
Compressions Straps
Air Release Valve



EXTERNAL POCKET
With cardholder
window



REFLECTIVE ELEMENTS



EASY TRANSPORT
3 Carrying Handles
Paddle Shoulder Straps



ULTRA DURABLE MATERIAL

- 1500h UV Resistance
- 500D PVC Tarpaulin

SW38 | WATERPROOF
REAR DUFFLE BAG

X28 Y54 Z28 (cm).
Ref. X0SW38



Icon descriptions Page 103



INCLUDED

FITTING STRAPS



INCLUDED

SHOULDER STRAP



IB20 | WATERPROOF
REAR BAG

Ø 25,5 Z53,5 (cm).
Ref. X0IB20



ACCESSORIES FOR BAGS

MAGNETS (4U.)
SL20F / E04
Ref. X1SL11



FILM PROTECTOR
Ref. X1SL02



UNIVERSAL BASE TANK
SL20F/ E04
Ref. X1SL90



DUFFLE BAG IB08
Ref. X0IB08



LOCK MECHANISM + KEYS
E02/E03/E09
Ref. X1SESTLR



THERMO PAD
E48/SL58
Ref. X1SB97



SMARTPHONE HOLDERS

MIRROR AND HANDLEBAR SYSTEM



SHAD ENGINEERED MOUNTING



360° SUPPORT

HANDLEBAR SIZES

Ø 20-40 MM

SMARTPHONE CASE



- 1 LIGHT RAIN RESISTANT CASE
- 2 CABLE OUTLET
- 3 TOUCH SCREEN

X-FRAME SYSTEM

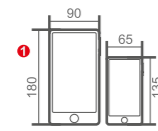

- 1 PHONE SIZES
- 2 SAFETY TETHER
- 3 RUBBER GRIPS
- 4 DESK SUPPORT

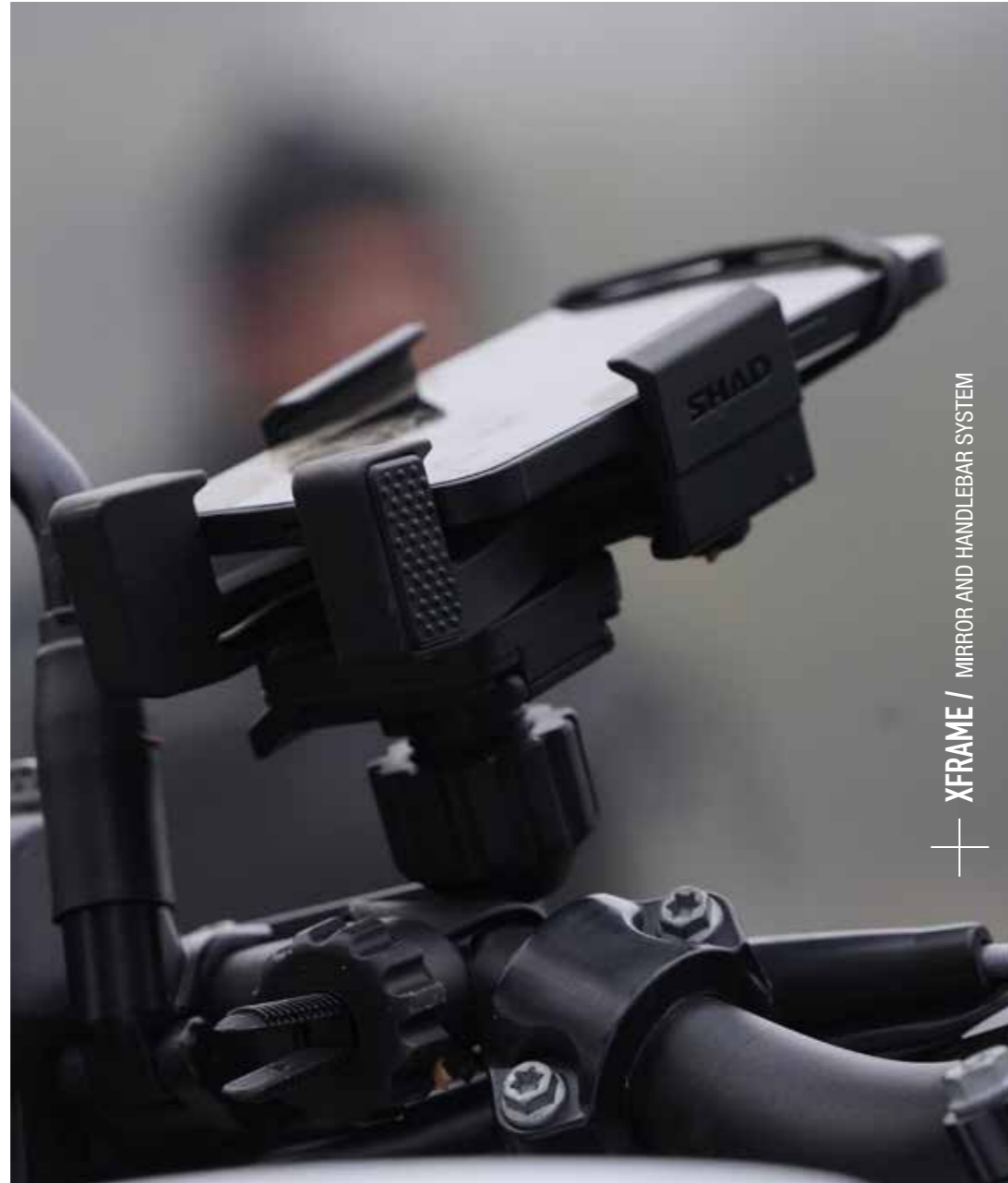

XFRAME / MIRROR AND HANDLEBAR SYSTEM

X-FRAME



MAX. PHONE SIZE **180x90** mm

HANDLEBAR HOLDER

Ref. X0SG00H



MIRROR HOLDER

Ref. X0SG00M



SMARTPHONE HOLDERS WITH POCKET

HANDLEBAR HOLDER



Ref. X0SG76H

MIRROR HOLDER



Ref. X0SG76M

MAX. PHONE SIZE

180x90 mm

SMARTPHONE HOLDERS

HANDLEBAR HOLDER



Ref. X0SG62H

MIRROR HOLDER



Ref. X0SG62M

MAX. PHONE SIZE

160x90 mm

180x90 mm

Ref. X0SG71H

Ref. X0SG71M

RAIN JACKET



Size	cm	Ref.
S	57	X0SR55S
M	59.5	X0SR55M
L	62	X0SR55L
XL	64.5	X0SR55XL
XXL	67	X0SR55XXL
3XL	69.5	X0SR553XL

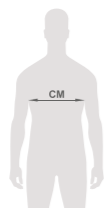

RAIN PANTS



Size	cm	Ref.
S	34	X0SR20S
M	36.5	X0SR20M
L	39	X0SR20L
XL	41.5	X0SR20XL

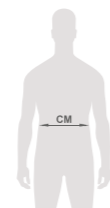

HAND MUFFS

X36.5 Y26 Z50 cm
Ref. X0SR00

- Quick Fitting
- Fur lining
- Adaptable to a majority of motorcycles
- Reflective



ATV CASES

ATV110

X58.5 Y93 Z34 cm
Ref. D0Q1100



ATV80

X55 Y90 Z26 cm
Ref. S0Q800



ATV40

X37 Y74 Z19 cm
Ref. D0Q200



SHAD LOCKS



SH47 TOP CASE / SHAD LOCK SERIE 3

PREMIUM LOCK CYLINDER

REVERSIBLE PREMIUM KEY AND PREMIUM LOCK CYLINDER WITH UP TO 30.000 CYCLES



DIFFERENT FITTING DEVELOPMENTS

SPECIFIC FITTING DEVELOPMENTS FOR MOUNTING SHAD LOCKS IN YOUR MOTORCYCLE



SECURITY SOLUTION

ANTI-THEF SOLUTION WITH A CLEAN, FAST AND PRACTICAL SYSTEM TO IMMOBILIZE THE VEHICLE



WATER RESISTANCE

WATER AND CORROSION RESISTANT, TO ENSURE A LONG PRODUCT LIFE IN ANY ENVIRONMENT



SHAD LOCKS



Icon descriptions Page 103

HOW TO BUY

STEP 1: FIND YOUR FITTING REFERENCE

Check the lock size



CHECK BIKE COMPATIBILITY



STEP 2: CHOOSE LOCK SERIE

SERIE 2



SERIE 3



Serie 3



Serie 3

SERIE 2

SHAD LOCKS FEATURES

- Diam. 35mm thick metal chain
- Quick usage
- Integrated design to handlebar
- Premium Lock Cylinder
- Premium Key
- Chain Protection cover
- Head Rotation 360°
- REACH components
- Allows helmet locking



- | | |
|-----------------------|-----------------------|
| LARGE (49 CM) | SC207H – Ref. C0S207H |
| MEDIUM (44 CM) | SC205H – Ref. C0S205H |
| SMALL (38 CM) | SC203H – Ref. C0S203H |

SERIE 3

SERIE 3 EXTRA FEATURES

- Diam. 35mm thick metal chain
- Quick usage
- **Side use: Comfort and water resistance**
- Integrated design to handlebar
- Premium Lock Cylinder
- Premium Key
- **Inaccessible cylinder lock fitting**
- Chain Protection cover
- **Invisible assembly head-chain**
- Head Rotation 360°
- REACH components
- Allows helmet locking
- **Pad printed graphics**



- | | |
|-----------------------|-----------------------|
| LARGE (49 CM) | SC307H – Ref. C0S307H |
| MEDIUM (44 CM) | SC305H – Ref. C0S305H |
| SMALL (38 CM) | SC303H – Ref. C0S303H |

DISC LOCKS



WATERPROOF RUSTPROOF 2 KEYS
Icon descriptions Page 103

SECURE

PIN 6 MM. / 10 MM.

FAST

PUSH DOWN LOCK PIN
FOR EASY LOCKING

COLOUR OPTIONS

AVAILABLE IN YELLOW AND BLACK



SC21

X57,7 Y51 Z37,5 cm
■ Black Ref. C0S2100
■ Yellow Ref. C0S2103



INSTALLATION

Pin 6 mm. Suitable for motorcycles, scooters and bikes.

WATER RESISTANCE

Waterproof. Corrosion prevention.

DESIGN

Unique design lock body.

MAIN MATERIAL

Solid Zinc Alloy.
Strong paint finishing.

FUNCTIONALITY

Push down lock pin for easy locking. 2 keys included.

SC61A ALARM 120 dB

X82,5 Y56,6 Z50 cm
■ Black Ref. C0S6100A
■ Yellow Ref. C0S6103A



INSTALLATION

Pin 6 mm. Suitable for motorcycles, scooters and bikes.

SECURITY

Built-in 120dB alarm. On/Off alarm selection. Motion and shock sensors.

WATER RESISTANCE

Waterproof. Corrosion prevention.

DESIGN

Unique design lock body.

MAIN MATERIAL

Solid Zinc Alloy.
Strong paint finishing.

FUNCTIONALITY

Push down lock pin for easy locking. 2 keys included.
CR2 lithium battery included (non rechargeable – long life battery)

SC62A ALARM 120 dB

X82,5 Y56,6 Z50 cm
■ Black Ref. C0S6200A
■ Yellow Ref. C0S6203A



INSTALLATION

Pin 10 mm. Suitable for motorcycles, scooters.

SECURITY

Built-in 120dB alarm. On/Off alarm selection. Motion and shock sensors.

WATER RESISTANCE

Waterproof. Corrosion prevention.

DESIGN

Unique design lock body.

MAIN MATERIAL

Solid Zinc Alloy.
Strong paint finishing.

FUNCTIONALITY

Push down lock pin for easy locking. 2 keys included.
CR2 lithium battery included (non rechargeable – long life battery)

EXHIBITIONS

If you're thinking about renewing or improving your SHAD display, or planning a product presentation or any similar event, just reach out to your representative. We're here to help and offer the solution that fits you best.



CHECK OUR SHAREPOINT FOR UPDATED INFORMATION

Exhibition guides
PDF display guides
PLV List



DISPLAYS

FLOOR

4P SYSTEM

TOP CASE + TERRA CASE & BAGS/
SIDE CASES
Ref. D0TR201



3P SYSTEM

TOP CASE + TERRA BAGS/SIDE
CASES

Ref. D0EX58



Ref. D0EX201

CLICK SYSTEM

Ref. D0CS201



3 UNITS TOP CASES/CLICK SYSTEM BAGS

D0EX33 (1U.) + D0EX02 (1U.)/
D0EX10 (1U.)/D0EX14 (1U.)



9 UNITS TOP CASES & CLICK SYSTEM BAGS

D0EX03 (1U.) + D0EX02 (1U.) +
D0EX10 (1U.) + D0EX14 (1U.)



WALL

3 TOP CASES

Ref. D0EX02



3 BIG TO CASES

SH59-SH58-SH51-SH58
Ref. D0EX10



4 CLICK SYSTEM BAGS

Ref. D0EX14
Ref. D0EX59



1 UNIT TOP CASE/CLICK SYSTEM BAG

Ref. D0EXTRP



3P SYSTEM

1 UNIT TERRA BAG/SIDE CASE
Ref. D0EXIF



4P SYSTEM

1 UNIT TERRA CASES & BAGS /
SIDE CASE
Ref. D0EX04P



SADDLE BAGS

SR38/SL58/E48/E48SR
Ref. DE0X19SR



SLATWALL

**1 UNIT TOP CASE/
CLICK SYSTEM BAG**
Ref. D0EXTRR



DESK

1 UNIT SH38X
Ref. D0EX38IF



1 UNIT CLICK SYSTEM BAGS
Ref. D0EX02CS



4 UNITS DISK LOCKS
Ref. D0EX01CS



SHAD WEAR

SHAD BUFF
Ref. 999319



JACKET
SIZES S, M, L & XL
Ref. 999361S/M/L/XL



SHAD POLO
POLO- SIZES S, M, L, XL, XXL
Ref. 999104S/M/L/XL/XXL



SHIRT
MAN.- SIZES S, M, L, XL
Ref. 999200/201/202/203/204

WOMAN.- SIZES S, M, L, XL
Ref. 999396S/M/L/XL



MERCHANDISING

COTTON BAG
Ref. 999102



SMALL STICKER
10 X 3,2CM
Ref. 999107



MINI CASE
Ref. 999114



ALUMINIUM BOTTLE
CAPACITY 500 ML
Ref. 999106



LANYARD "SHAD"
Ref. 999367



OFFICIAL DEALER STICKER
WALL
Ref. 999111
WINDOW
Ref. 999112



SHAD PEN
Ref. 999101



SHAD KEY RING
Ref. 999103



SHAD MULTIFUNCTION TOOL
MEASURES: 5,5 CM X 9,00 CM
Ref. 999142



NOTEBOOK
RECYCLED PAPER
Ref. 999300



PLV



ROLL UP TERRA
84 X 204 CM
Ref. 999308



ROLL UP EXPANDABLE
84 X 204 CM
Ref. 999368

PLV

TENT 3X3 M
Ref. 999366



BANNER
220 X 50CM
Ref. 999350



CARPET – 120 X 180CM
Ref. 999353



CHECK OUR SHAREPOINT FOR UPDATED INFORMATION
Exhibition guides
PDF display guides
PLV List



ICON DESCRIPTIONS

SPARE PARTS



Check here the spare parts for your case

SHAD SUPPORT



YOUTUBE SUPPORT CHANNEL:
Technical info
Spare parts installation
Accessories mounting guide

CAPACITY



2 flip-up helmets



2 full face helmets



2 helmets: full face and jet



2 Trail helmets



2 helmets: flip-up and jet



1 flip-up helmet



1 full face helmet



1 jet helmet



2 jet helmets



Capacity

FEATURES



Expandable



Maximum load



Secure lock system



Compression straps



Waterproof IP Grade



Reflector



+40% volume expandable



Integrated



Double Locking System



Quick assembly



Clean



Click System bag with lock



Helmet holder



Secure



Waterproof



Rustproof



Magnet

FITTING KITS



Side Bag Holder



Click System bag



Handlebar bracket



Mirror Bracket



SR Side Bag Holder with lock



SR Side Bag Holder



4P System



3P System

MATERIALS



Semi rigid



Aluminium case

SHAD

ENGINEERED FOR RIDING

SHAD WORLD (BARCELONA)

Octave Lecante 2-6 -Pol. Ind. Can Magarola
08100 Mollet del Vallès · Barcelona · Spain
Tel. +34 935 795 866
NAD Clients Tel. +34 935 795 860
Fax: +34 935 796 945

SHAD ESPAÑA

Tel. +34 935 795 870

SHAD FRANCE

Tel. +34 935 795 868

SHAD ITALY

Tel. +34 935 795 867

SHAD USA

19098 NE 4th Court Miami FL, 33179- USA

SHAD CHINA

T: (+86)21- 62365730
Room 232, Building B, No.668 Hengfeng Road,
Jing'An District, 200070-Shanghai - China

SHAD INDONESIA

Jl. Kemang Selatan VIII No. 56 Unit B
Jakarta 12730 Indonesia
Tel. +62 2122718560

SHAD PHILIPPINES

8th Floor, Marajo Tower, 312
26th Street West corner
4th Avenue, Bonifacio Global City,
Taguig Philippines 1634

info@shad.es

WWW.SHAD.ES

Code: 999370



8430358665446

CERTIFIED
ISO 9001
ISO 14001

