



**AKRAPOVIC BOLT-ON & BOLT-ON STREET LEGAL EXHAUST SYSTEM
for the
KAWASAKI ZX-10 R (2006)**

Congratulations on purchasing an Akrapovic exhaust system. Please read these installation instructions carefully. If you have any trouble installing the system please contact your authorized dealer!

IMPORTANT INFORMATION

Exclusion of Certain Liability

1. The manufacturer, importer or dealer shall not be liable for any incidental damage including personal injury or any other damages caused by improper installation or operation of the Akrapovic exhaust system. When installing the Akrapovic exhaust system be careful that the exhaust system does not touch other parts sensitive to high temperature.
2. Akrapovic makes no representation or warranties with regard to damage caused by the improper installation, use and maintenance of the Akrapovic exhaust system. The warranty is limited to defects recognized by our technical department and to normal use, and excludes items subject to normal wear (gaskets and damping wool). The guarantee is void in case of accident, modification, improper or competition use.
3. Do not attempt to install the Akrapovic exhaust system on a motorcycle for which it was not made or tested by Akrapovic.
4. When the exhaust system gets very hot during operation, be careful not to burn yourself on the exhaust system or parts which are in direct contact with it, even when the motor is not running. Also protect other people, especially children, from the injuries mentioned above.
5. In some cases Akrapovic exhaust system kits contain chemical products (ceramic anti-seizing grease; bolt sealant). Handle with care, do not inhale or swallow. Avoid excessive contact with skin, eyes or mucous membranes. Keep out of reach of children.
6. Technical specifications of Akrapovic exhaust systems and related products subject to change without notice.

Trademarks

The Akrapovic Exhaust System Technology logo is a registered trademark of Akrapovic d.d.

Akrapovic website

Information about Akrapovic exhaust systems and related products is available on the Akrapovic website at:
<http://www.akrapovic-exhaust.com/>

Copyright

No part of the Akrapovic exhaust system or its documentation may be reproduced or distributed in any form or by any means without the prior written authorization of the Akrapovic company.





© Akrapovic d.d. All rights reserved.

Symbols

The following symbols are used throughout these installation instructions:



INSTALLATION INSTRUCTIONS

- | | |
|---|---|
|  | BEFORE INSTALLING CHECK SCHEMATIC OF THE EXHAUST SYSTEM! |
|  | IF ANY ITEMS IN THE AKRAPOVIC EXHAUST SYSTEM PACKAGE ARE MISSING PLEASE CONTACT YOUR AUTHORIZED DEALER. KEEP THE SCHEMATIC FOR FUTURE REFERENCE. |
|  | THESE INSTALLATION INSTRUCTIONS MUST BE READ CAREFULLY IN ORDER TO ENSURE PROPER INSTALLATION AND OPERATION OF THE AKRAPOVIC EXHAUST SYSTEM. |
|  | THE EXHAUST SYSTEM CAN BE EXTREMELY HOT. ALLOW THE MOTORCYCLE TO COOL DOWN BEFORE BEGINNING INSTALLATION. |
|  | WE ADVISE YOU TO LEAVE INSTALLATION TO A QUALIFIED SERVICEMAN. IMPROPER INSTALLATION MAY RESULT IN A SHORTER LIFETIME OF THE EXHAUST SYSTEM AND/OR DAMAGE TO THE MOTORCYCLE. |

REMOVAL OF STOCK EXHAUST SYSTEM

1. put the motorcycle on a side stand, we recommend racing stand
2. remove the passengers seat (**Figure 1**)
3. remove the side panels and the drivers seat (**Figure 2, 3, 4**)
4. carefully remove all fastenings which fix the rear cowling (**Figure 5, 6, 7, 8, 9**)
5. lift up the rear cowling and disconnect the rear light and turn indicators connectors (**Figure 10, 11, 12, 13**)
6. disconnect the cable for the passengers seat lock (**Figure 14**)
7. remove the rear cowling (**Figure 15**)
8. unscrew the bolts and remove both brackets for the passengers footpegs (**Figure 16, 17, 18**)
9. unscrew and remove nuts from the muffler at the muffler - link pipe connection; repeat the process for the other muffler (**Figure 19**)
10. unscrew and remove the bolt from the muffler metal bracket and remove the muffler; repeat the process for the other muffler (**Figure 20, 21**)

INSTALLATION OF THE AKRAPOVIC BOLT-ON EXHAUST SYSTEM



installing the muffler:

1. install the copper gasket from the Akrapovic kit in the groove in the CNC ALU flange (**Figure 22**)
2. correctly orient the muffler and place it near the link pipe/header assembly (**Figure 23**)
3. when the muffler and the link pipe are together, attach using the bolts from the Akrapovic kit. Coat each bolt individually with bolt sealant before installing. (**Figure 24**) Tighten the bolts only hand tight – do not fully tighten (**Figure 25, 26**)
4. correctly position the carbon-fiber clamp and slide it onto the muffler - bear in mind the right offset of the carbon-fiber clamp for the left muffler and the left offset for the right muffler viewed from the rear. **WARNING:** open the clamp to slightly wider than the diameter of the outer sleeve of the muffler – do not scrape it along the muffler outer sleeve! (**Figure 27**)
5. tighten fully the carbon-fiber clamp onto the frame – use the bolts and washers from the Akrapovic kit (**Figure 28, 29, 30**)
6. repeat the process for the other muffler
7. tighten fully the titanium bolts on the CNC ALU flange at the muffler – link pipe connection

final installation:

1. replace the rear cowling (**Figure 31**)
2. reconnect light and turn indicators connectors (**Figure 32, 33, 34**)
3. reattach the cable for the passengers seat lock (**Figure 35**)
4. reattach all fastenings which fix the rear cowling (**Figure 36, 37, 38, 39**)
5. reattach the bracket for the passengers footpeg; repeat the process for the other muffler (**Figure 40, 41, 42**)
6. replace the drivers seat and side panels (**Figure 43, 44, 45, 46**)
7. replace the passengers seat (**Figure 47**)
8. clean grease spots:
 - a. muffler – titanium outer sleeve: use a soft cloth sprayed with a multi-purpose spray lubricant (WD-40 or equivalent)
Cleaning will prevent spots from burning onto the surface. Do not use aggressive chemical cleaners, because they can damage the sticker.
9. position of the correctly installed Akrapovic BOLT-ON system (**Figure 48**)

Check the operation of the brakes and suspension. Make sure all the bolts are sufficiently tightened. In case the exhaust system touches the cowling or other parts repeat the adjustment of the exhaust system or contact your authorized dealer.

- | | |
|---|---|
|  | IT IS NORMAL IF WHITE SMOKE COMES OUT OF THE MUFFLER ON FIRST OPERATION. |
|  | DO NOT STAND BEHIND THE MUFFLER ON FIRST OPERATION. |
|  | DO NOT USE AUTOMOTIVE WHEEL CLEANERS OR ANY CLEANING PRODUCTS WHICH CONTAIN ACIDIC ADDITIVES TO CLEAN AKRAPOVIC EXHAUST SYSTEMS. |

MAINTENANCE OF THE AKRAPOVIC EXHAUST SYSTEM

1. Clean the titanium muffler outer sleeve with a multi-purpose spray lubricant (WD-40 or equivalent). Do not use aggressive chemical cleaners, because they can damage the sticker. A change in the color of the exhaust system is normal due to the high temperatures.
2. The wearing out of the muffler silencing material depends on the type of the motor and riding style. Contact your dealer/serviceman if visible changes appear on muffler's outer sleeve or the noise level is increased.
3. Periodically make sure all the bolts are sufficiently tight.

Photos:



Figure 1



Figure 2



Figure 3



Figure 4



Figure 5



Figure 6



Figure 7



Figure 8



Figure 9



Figure 10

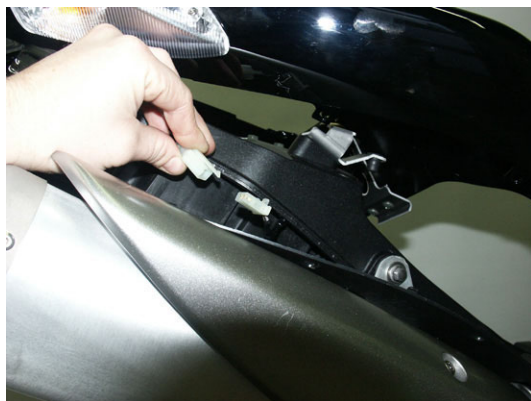

Figure 11



Figure 12



Figure 13

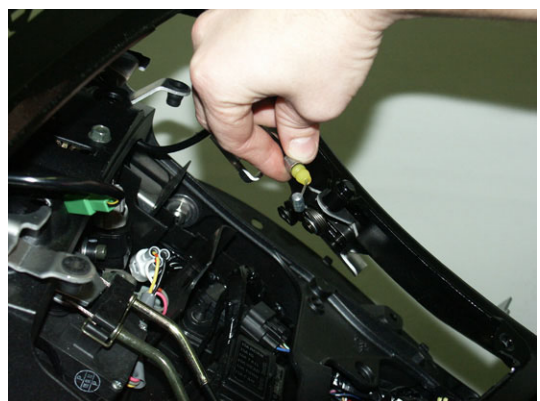

Figure 14



Figure 15



Figure 16



Figure 17

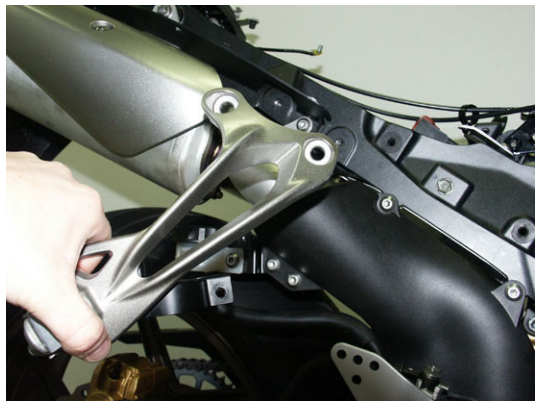

Figure 18



Figure 19

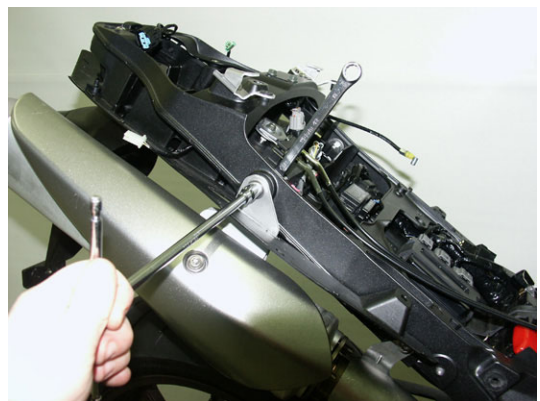

Figure 20



Figure 21



Figure 22



Figure 23

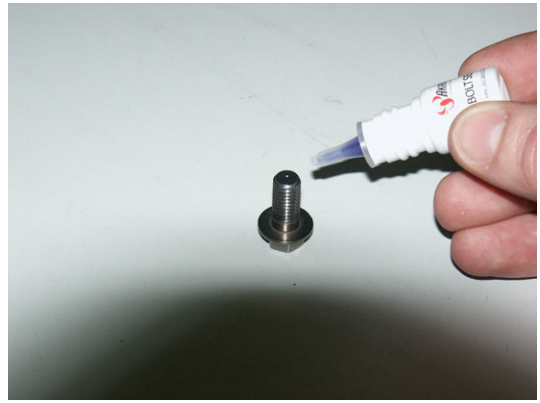

Figure 24



Figure 25

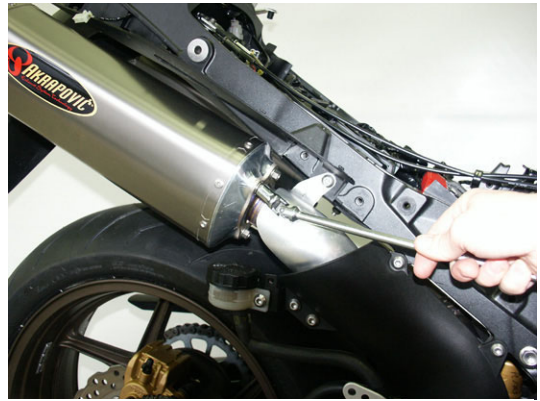

Figure 26



Figure 27



Figure 28



Figure 29



Figure 30



Figure 31



Figure 32



Figure 33



Figure 34



Figure 35



Figure 36

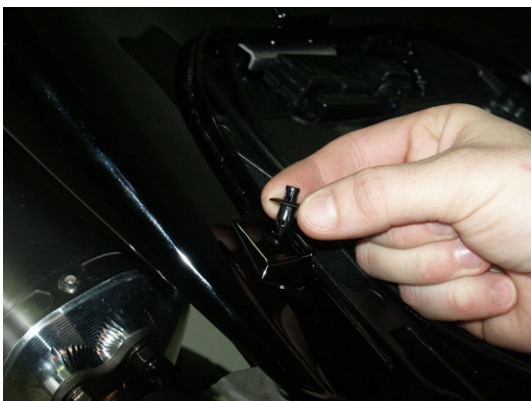

Figure 37



Figure 38



Figure 39



Figure 40



Figure 41



Figure 42



Figure 43



Figure 44

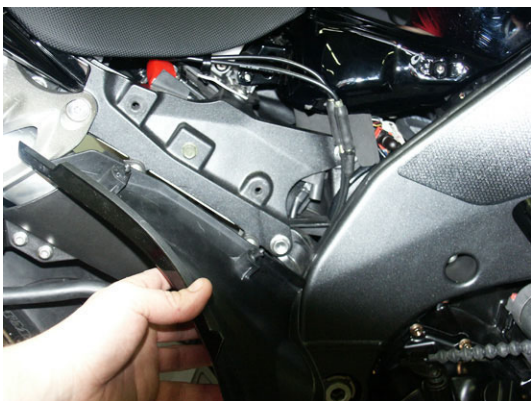

Figure 45

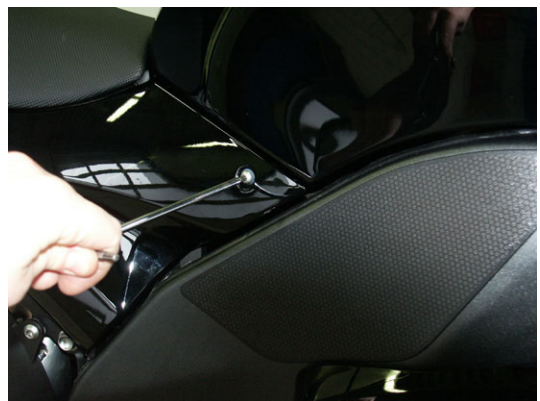

Figure 46



Figure 47



Figure 48

Kawasaki ZX-10R, model year: 2006, bolt-on exhaust system, OPEN

Product code: 105180 (S-K10BO1-ZC)
105179 (S-K10BO1-ZT)

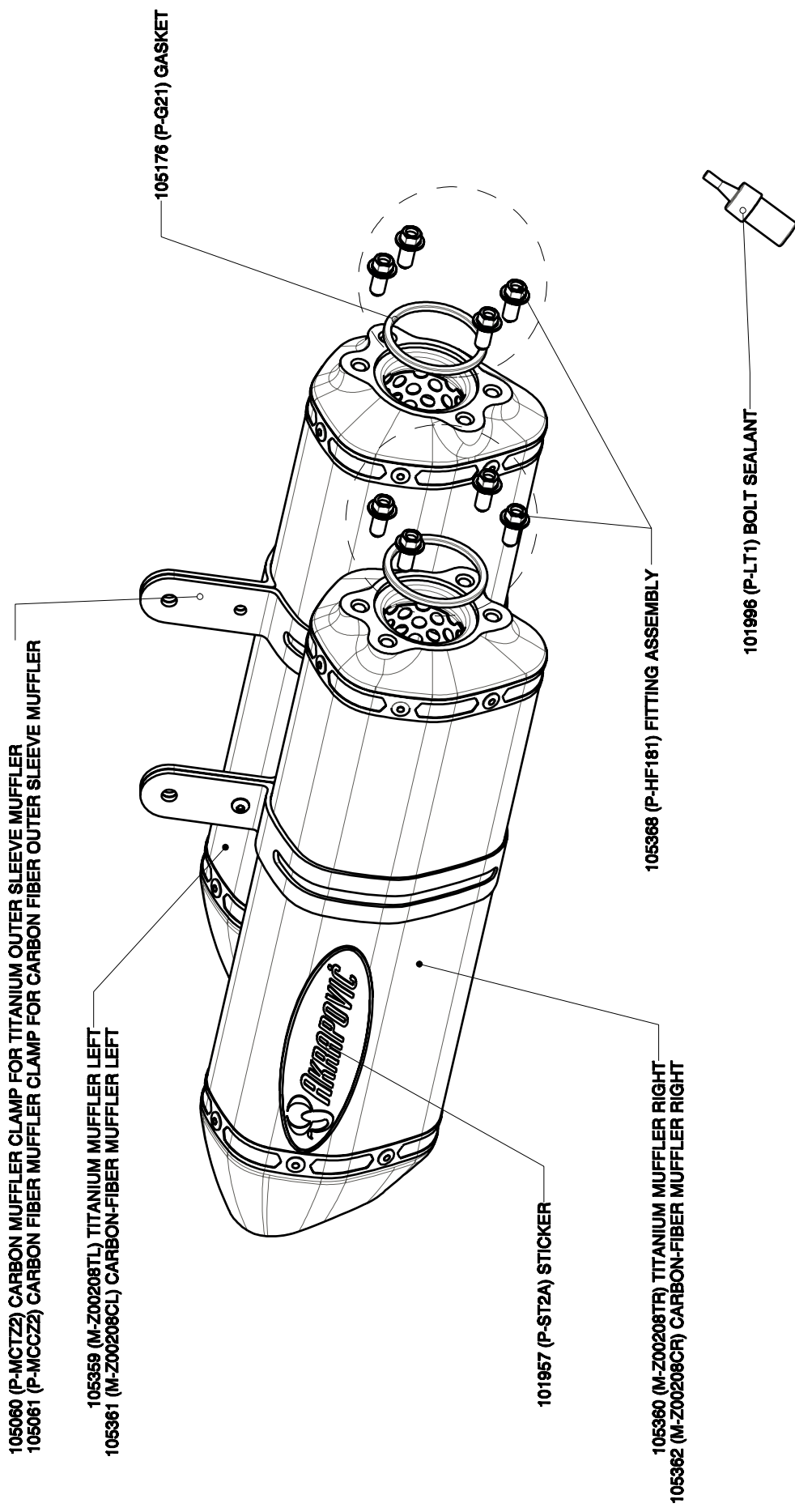

Kawasaki ZX-10R, model year: 2006, bolt-on exhaust system, homologated

Product code: 105178 (S-K10BO1-HZT)
105177 (S-K10BO1-HZC)

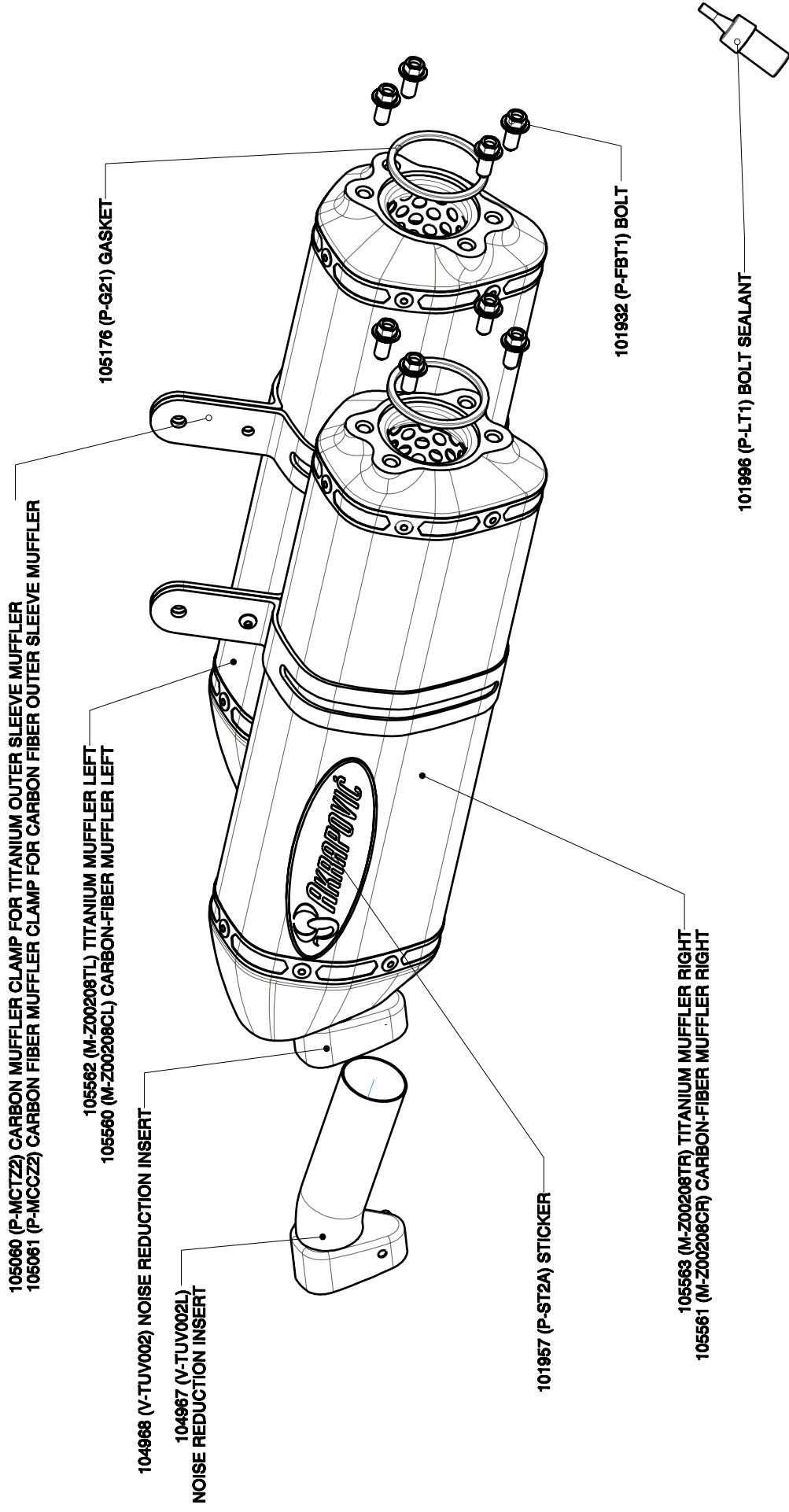

Kawasaki ZX-10R, model year: 2006, bolt-on exhaust system, street legal, FACTORY

Product code: 105726 (S-K10BO1-HKZT)
105727 (S-K10BO1-HKZC)

