



Installation instructions

Akrapovič Exhaust System:

Slip-On Classic

for the

Harley-Davidson

models:

SOFTAIL FATBOY (parallel mounted mufflers models)



504322

Congratulations on purchasing an Akrapovič exhaust system. Please read the entire installation manual prior to undertaking any activities related to installation of your new Akrapovič exhaust system. In case you do not fully understand the manual or any of its parts, please contact your authorized dealer!

This product should be installed by someone with sufficient knowledge of exhaust systems and their installation, and appropriate hand or power tools. If you are not qualified for this work, please utilize a certified mechanic for installation. By installing Your Akrapovič exhaust system, you indicate that you have read the installation manual in its entirety and you agree with the terms stated herein.

It is your responsibility to follow all installation instruction guidelines supplied with the Akrapovič exhaust system and undertake all necessary safety precautions. Akrapovič d.d. assumes no responsibility for damages occurring from misuse, abuse, improper installation, improper operation, lack of responsible care, or all previously stated reasons resulting from incompatibility with other manufacturer's products and/or systems.

IMPORTANT INFORMATION

Exclusion of Certain Liability

1. The manufacturer, importer or dealer shall not be liable for any incidental damage including personal injury or any other damages caused by improper installation or operation of the Akrapovič exhaust system. When installing the Akrapovič exhaust system be careful that the exhaust system does not touch other parts sensitive to high temperature.
2. Akrapovič makes no representation or warranties with regard to damage caused by the improper installation, use and maintenance of the Akrapovič exhaust system. The warranty is limited to defects recognized by our technical department and due to normal use, and excludes items subject to normal wear (gaskets and damping wool). The guarantee is void in case of accident, modification, improper or competition use.
3. Do not attempt to install the Akrapovič exhaust system on a vehicle model for which it was not made or tested by Akrapovič.
4. When the exhaust system gets very hot during operation, be careful not to burn yourself on the exhaust system or parts which are in direct contact with it, even when the engine is not running. Also protect other people, especially children, from the injuries mentioned above.
5. In some cases Akrapovič exhaust system kits contain chemical products (ceramic anti-seizing grease; bolt sealant). Handle with care, do not inhale or swallow. Avoid excessive contact with skin, eyes or mucous membranes. Keep out of reach of children.
6. Technical specifications of Akrapovič exhaust systems and related products are subject to change without notice.
7. Before removing the original exhaust system from your vehicle, please compare the parts you received with the list of materials provided in the installation manual in order to assure that you have all the parts necessary for the installation of your new Akrapovič exhaust system.
8. Although this manual consists of instructions for installation in written form, as well as photographs and pictures representing individual steps of the installation, please note that the photographs and pictures are symbolic and are intended for representation of general overview only. The photographs and pictures contained herein should serve as a guideline only and actual installation of the exhaust system may not correspond with the photographs and pictures entirely.
9. The process of uninstalling the original exhaust system may vary depending on the existing exhaust system. Please follow the original exhaust system manufacturer's instructions for uninstalling the original exhaust system.

Trademarks

The Akrapovič Exhaust System Technology logo is a registered trademark of Akrapovič d.d.

Akrapovič website

Information about Akrapovič exhaust systems and related products is available on the Akrapovič website at: <http://www.akrapovic.com/>

Copyright

No part of the Akrapovič exhaust system or its documentation may be reproduced or distributed in any form or by any means without the prior written authorization of the Akrapovič company.

© Akrapovič, d.d. All rights reserved.

Symbols

The following symbols are used throughout these installation instructions:



TOOLS REQUIRED



TIGHTENING TORQUE



INSTALLATION TIP



CAUTION OR WARNING



USE BOLT SEALANT; Apply 3 to 4 small drops of bolt sealant onto the cleaned and degreased threads before tightening the bolts. **WARNING! Avoid contact with skin, eyes and mucous membranes. Do not inhale fumes. Keep out of reach of children.**



USE ANTI-SEIZE LEAD-FREE COPPER PASTE (black tube); Provides trouble-free and long-lasting protection against seizing, corrosion and rusting of bolts, threaded ends, nuts, joints, etc. Also protects against vibration, wear and impact. **WARNING! Avoid eye contact. Avoid excessive skin contact. Keep out of reach of children.**



USE ANTI-SEIZING GREASE (white tube); Prevents seizing, corrosion and excessive wear between the titanium components of your exhaust system. **WARNING! Avoid eye contact. Avoid excessive skin contact. Keep out of reach of children.**

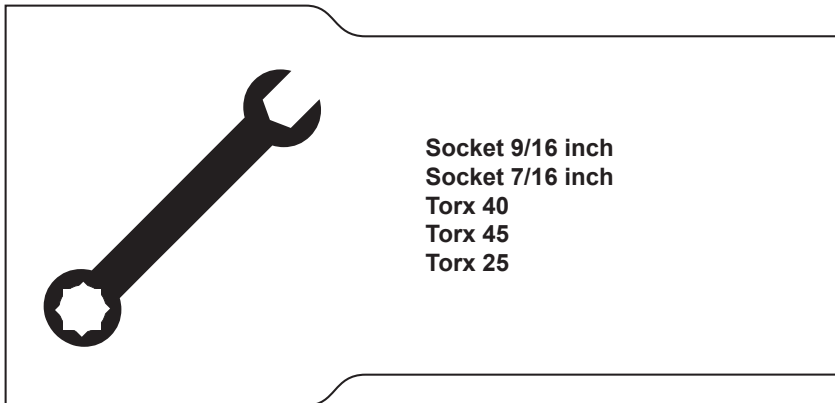

BEFORE INSTALLING, CHECK SCHEMATIC OF THE EXHAUST SYSTEM!



IF ANY ITEMS IN THE AKRAPOVIČ EXHAUST SYSTEM PACKAGE ARE MISSING, PLEASE CONTACT YOUR AUTHORIZED DEALER. KEEP THE SCHEMATIC FOR FUTURE REFERENCE.



THESE INSTALLATION INSTRUCTIONS MUST BE READ CAREFULLY IN ORDER TO ENSURE PROPER INSTALLATION AND OPERATION OF THE AKRAPOVIČ EXHAUST SYSTEM.



THE EXHAUST SYSTEM CAN BE EXTREMELY HOT. ALLOW THE EXHAUST AND ENGINE TO COOL DOWN BEFORE BEGINNING INSTALLATION.



WE ADVISE YOU TO LEAVE INSTALLATION TO A QUALIFIED SERVICEMAN. IMPROPER INSTALLATION MAY RESULT IN A SHORTER LIFETIME OF THE EXHAUST SYSTEM AND/OR DAMAGE TO THE VEHICLE.



THIS MANUAL IS SPECIFIC TO THE HARLEY DAVIDSON SOFTAIL FATBOY. THERE MAY BE SOME DIFFERENCES IN INSTALLATION PROCEDURES FOR OTHER SOFTAIL MODELS WITH PARALLEL MOUNTED MUFFLERS.



AKRAPOVIČ MAKES EVERY EFFORT TO PROVIDE IMPROVED CORNERING CLEARANCE FOR EXHAUST SYSTEMS. HOWEVER, DUE TO DESIGN AND SPACE LIMITATIONS ON SOME MOTORCYCLE MODELS, GROUND AND CORNERING CLEARANCE MAY NOT IMPROVE OR MAY EVEN BE REDUCED. FOR ADVANCED USERS, WE RECOMMEND INCREASING THE SPRING PRELOAD SETTINGS TO IMPROVE GROUND CLEARANCE.



THE AKRAPOVIČ WARRANTY DOES NOT COVER DISCOLORATION OF ANY CHROME PRODUCTS.

REMOVAL OF STOCK EXHAUST SYSTEM:

1. Put the motorcycle on a side stand, we recommend a center stand.
2. Unpin and remove rear right footrest (**Figure 1**).

! CAUTION: be careful not to damage any part of the motorcycle during this process!



Figure 1

3. Unscrew and remove rear right footrest bracket (**Figure 2**).

! CAUTION: be careful not to damage any part of the motorcycle during this process!

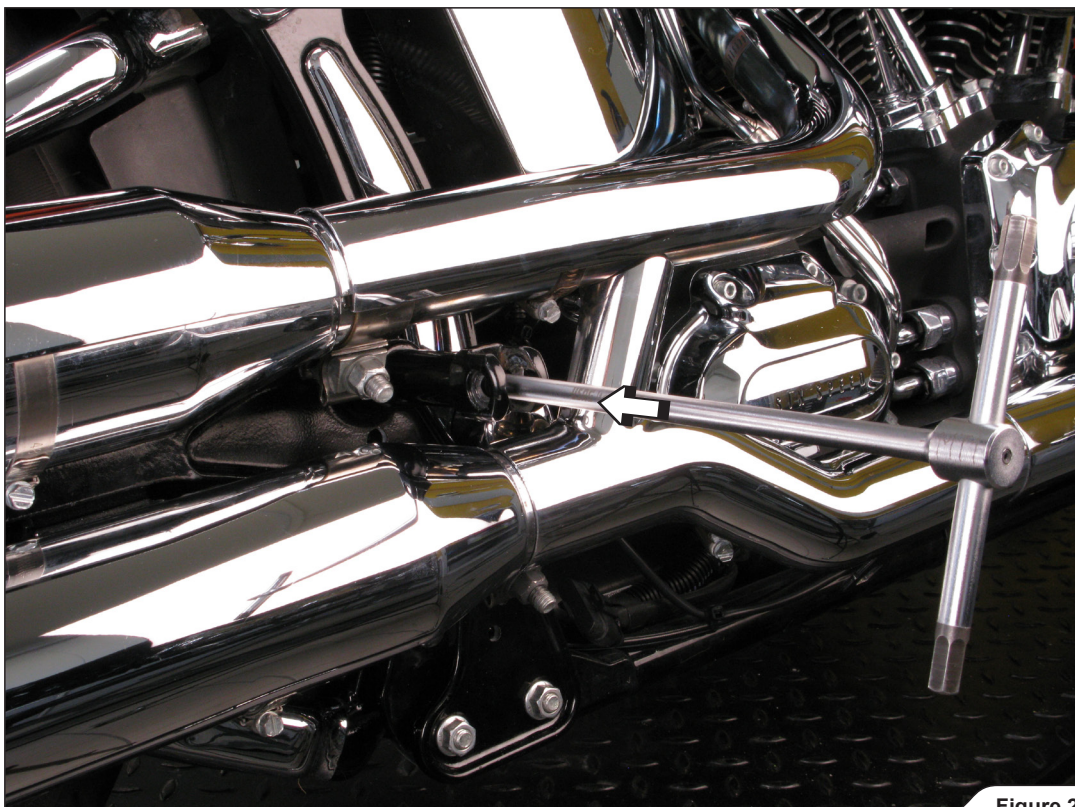

Figure 2

4. Loosen both muffler-header connection clamps and unscrew marked mufflers bracket bolts (Figure 3).
! CAUTION: be careful not to damage any part of the motorcycle during this process!



Figure 3

5. Loosen the marked heat shields' tape clamps and exhaust bracket (Figure 4).
! CAUTION: be careful not to damage any part of the motorcycle during this process!

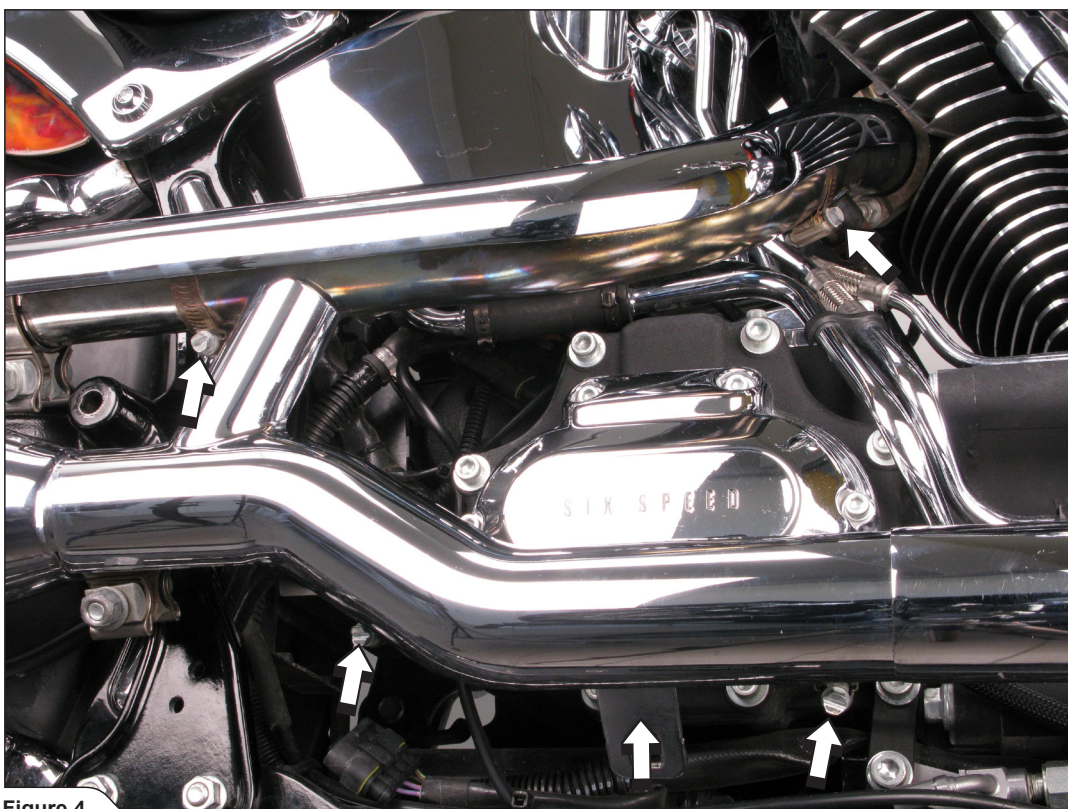

Figure 4

6. Loosen both headers' nuts (Figure 5, 6).

! **CAUTION:** be careful not to damage any part of the motorcycle during this process!

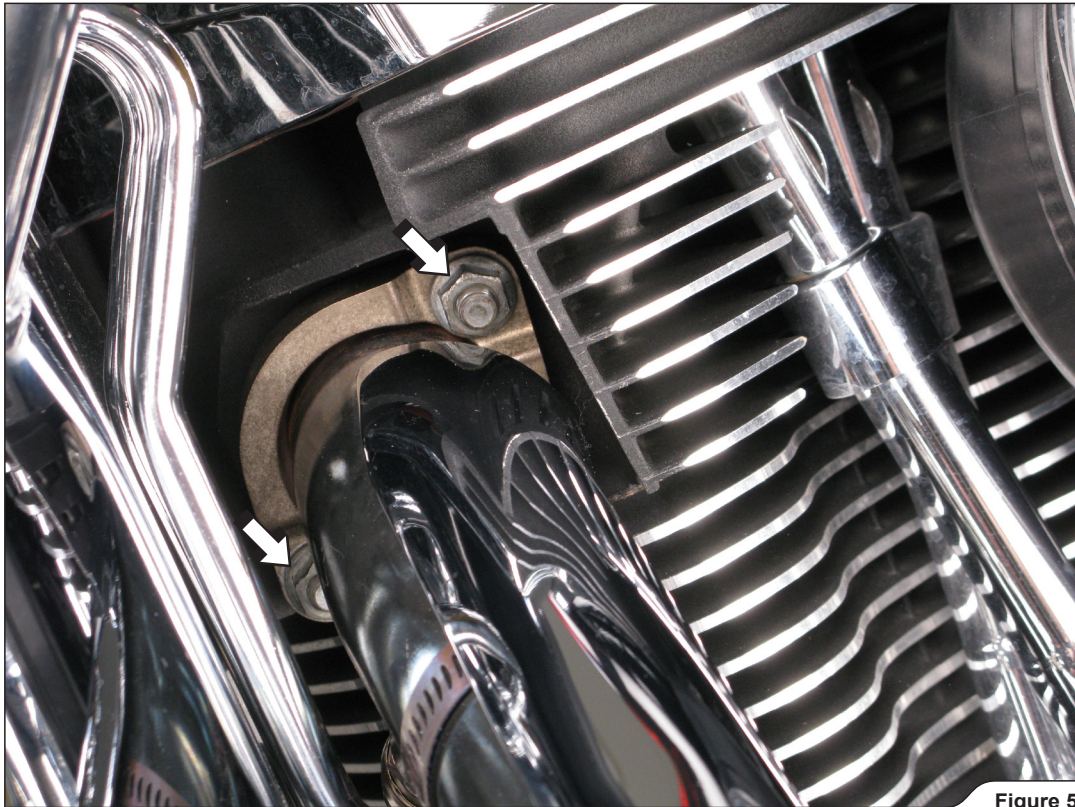

Figure 5



Figure 6

7. Unscrew marked bolts and disassemble mufflers from mufflers' bracket (Figure 7).
- ! **CAUTION:** be careful not to damage any part of the motorcycle during this process!



Figure 7

INSTALLATION OF THE AKRAPOVIČ EXHAUST SYSTEM:

1. Insert Akrapovič catalytic converters into mufflers (Figure 8, 9).
- ! **WARNING:** make sure, that you put the longer part of the catalyst into the muffler!
- ! **WARNING:** EC type approval IS VALID ONLY WHEN OPTIONAL CATALYTIC CONVERTER IS INSTALLED!



Figure 8



Figure 9

2. Correctly assemble the mufflers, link pipes, clamps, heat shields and stock mufflers' bracket (Figure 10, 11).
! WARNING: use anti-seize copper paste on all clamps' bolt threads!



Figure 10

- ! **WARNING:** make sure, that link pipes and mufflers are joint all the way – use rubber mallet if necessary to tap the connections into place!
- ! **WARNING:** hand tighten all clamps and bracket bolts only!

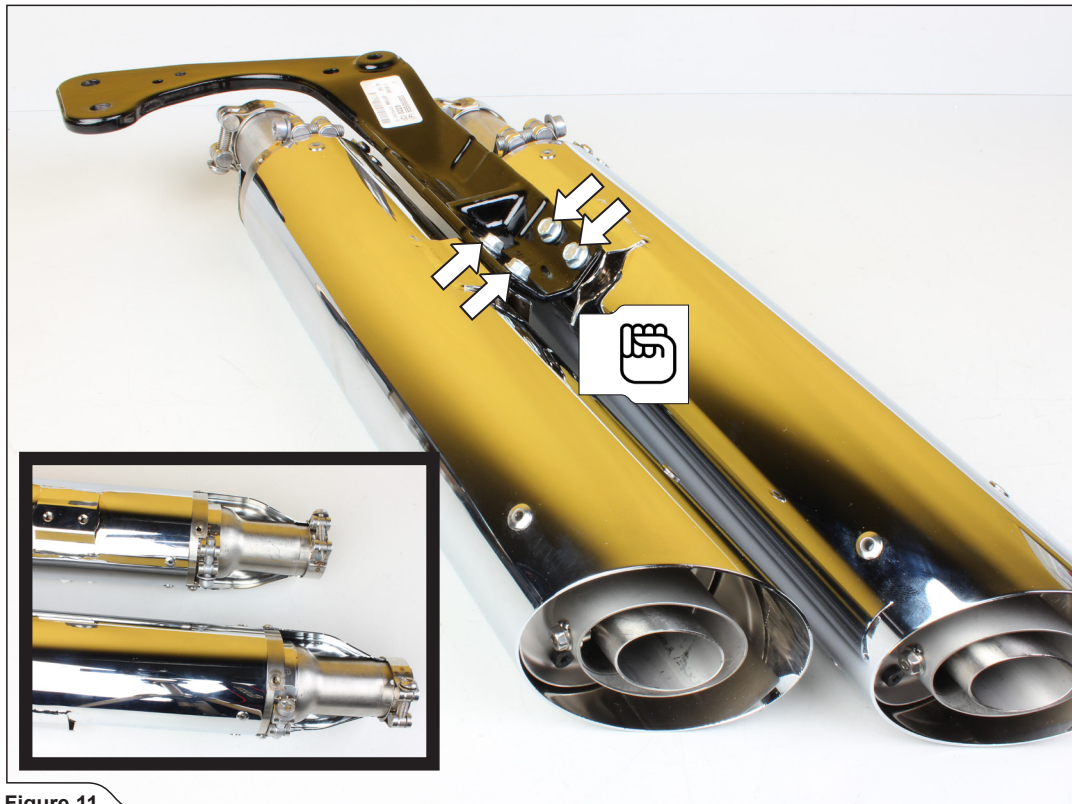

Figure 11

3. Put the marked distance washers (from Akrapovič installation kit) onto the brackets' stud bolts, as shown (Figure 12).
- ! **CAUTION:** be careful not to damage any part of the motorcycle during this process!

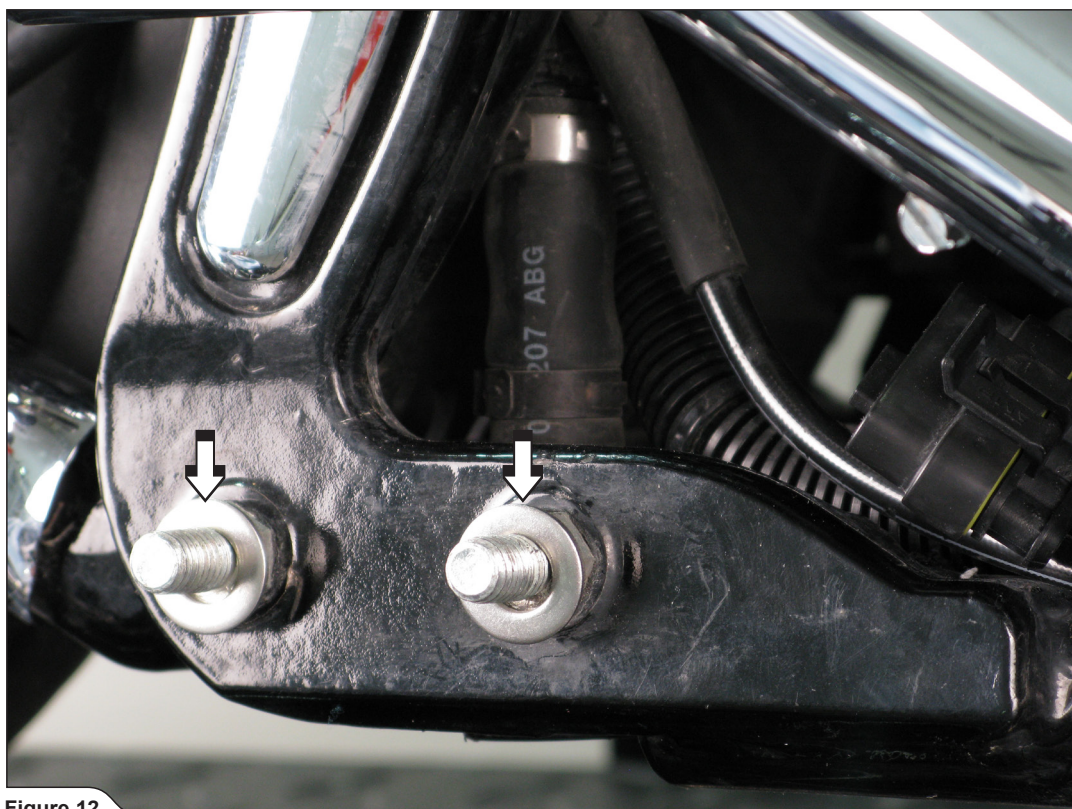

Figure 12

4. Put the marked distance washer (from Akrapovič installation kit) under the mufflers' bracket, as shown (Figure 13).
! CAUTION: be careful not to damage any part of the motorcycle during this process!

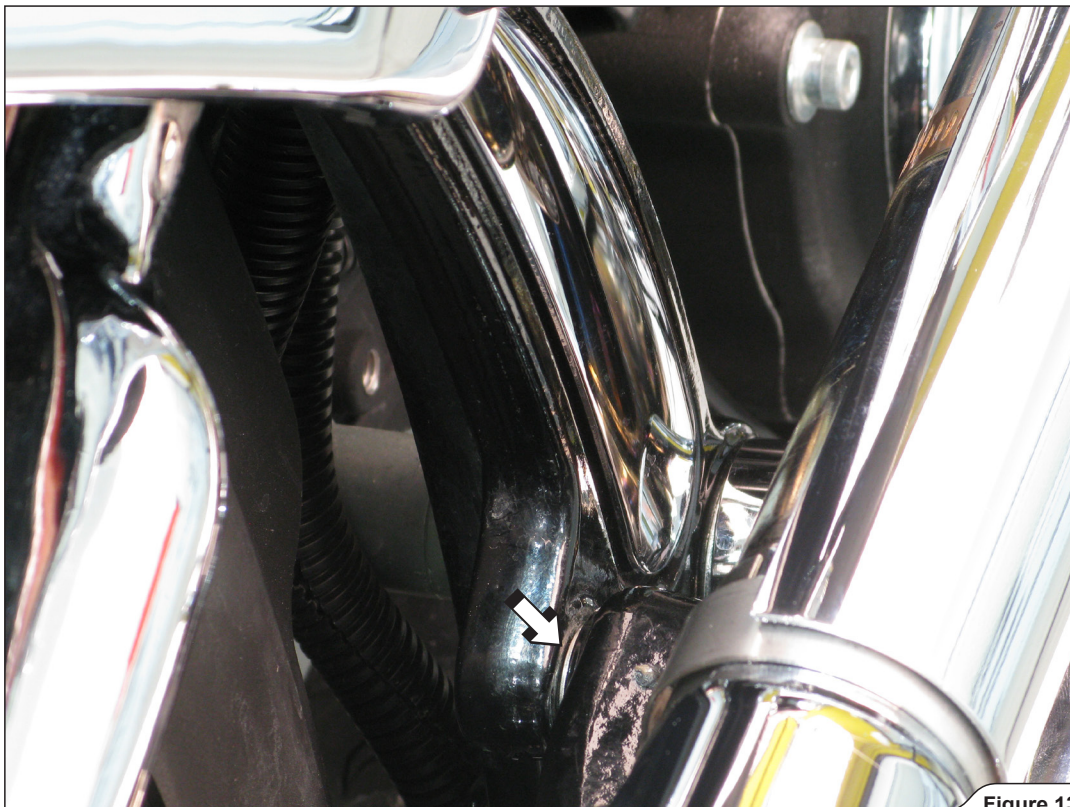

Figure 13

5. Slide the assembled mufflers onto the stock headers (Figure 14).
! CAUTION: be careful not to damage any part of the motorcycle during this process!



Figure 14

! CAUTION: make sure, the muffler-link pipe clamp position of upper muffler is upwards (Figure 15)!

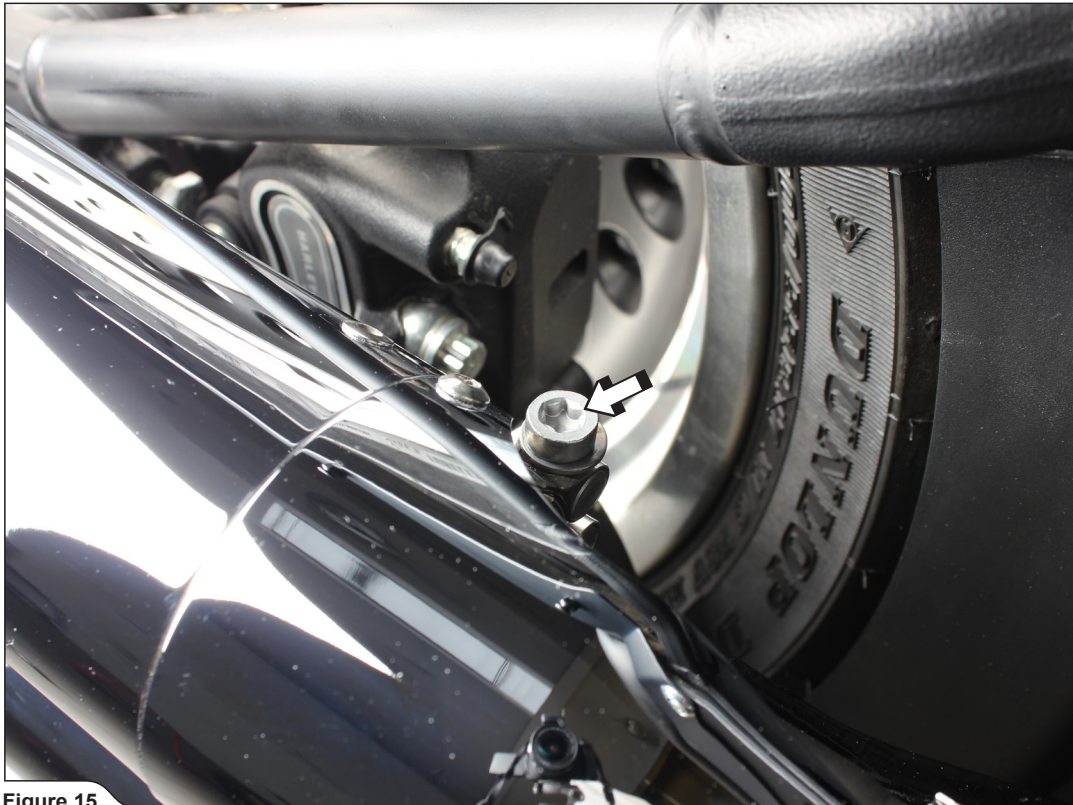

Figure 15

6. Align the mufflers in respect to the motorcycle. First tighten mufflers onto the original muffler bracket, then tighten the muffler - link pipe connection clamps and finally header - link pipe connection clamps (Figure 16, 17, 18).

! CAUTION: be careful not to damage any part of the motorcycle during this process!

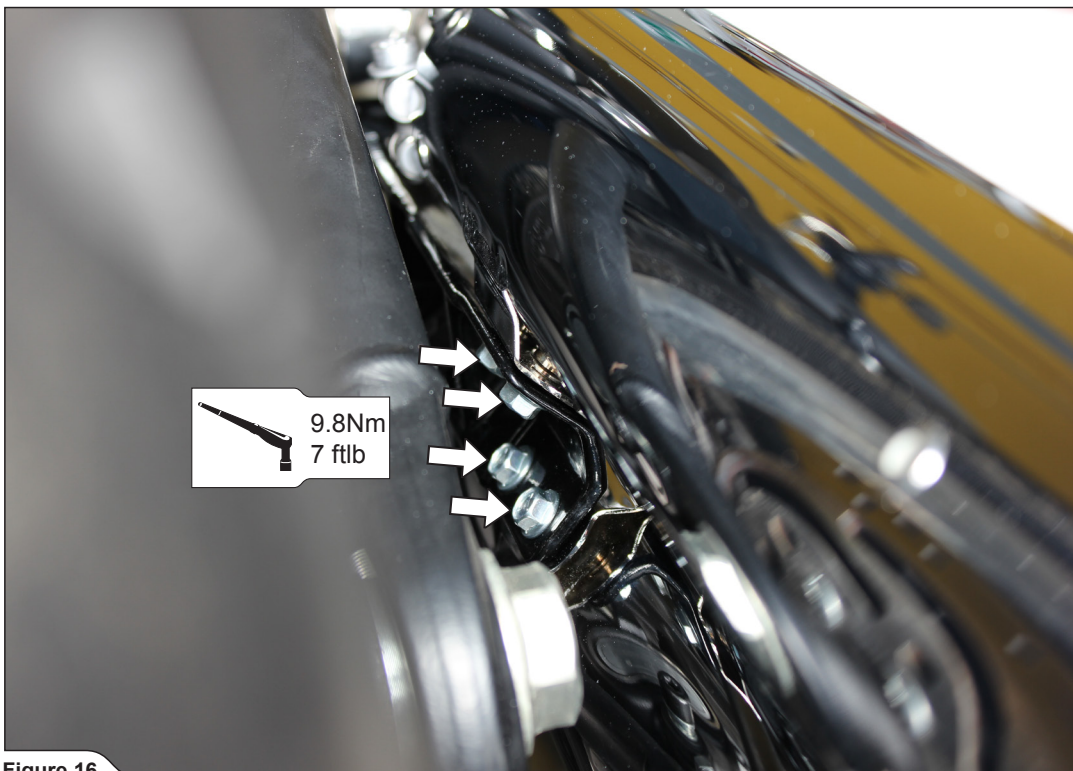
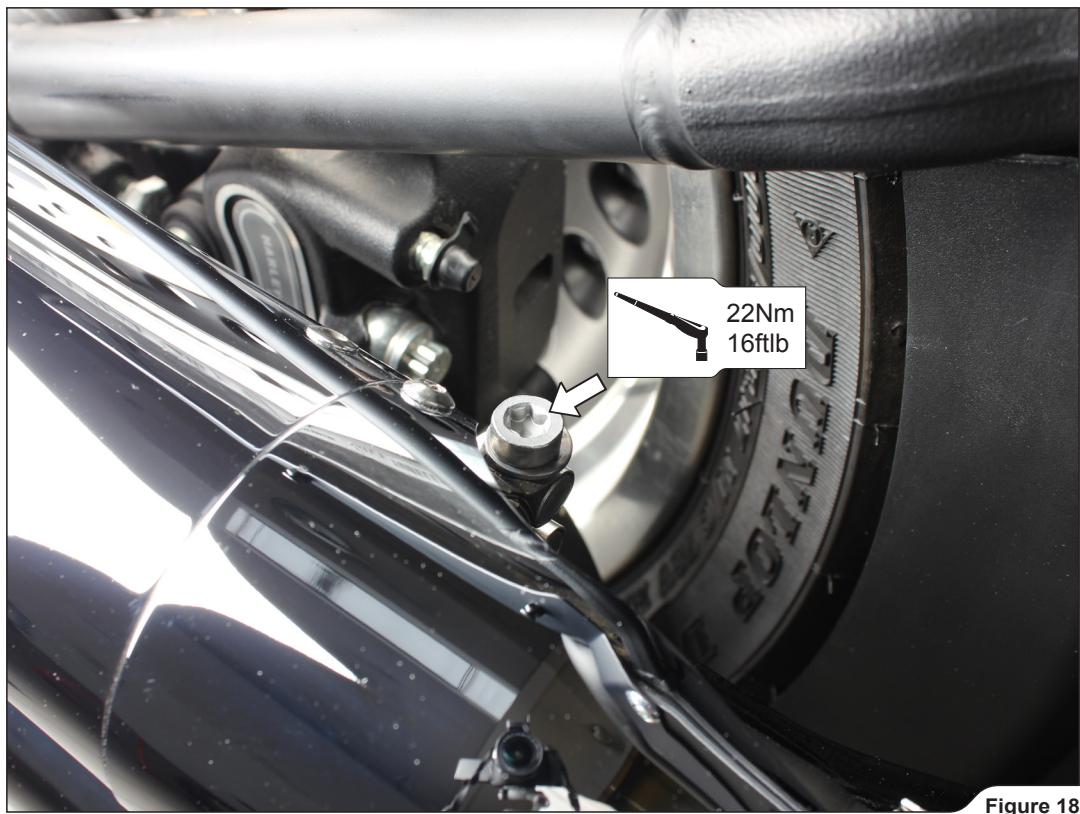
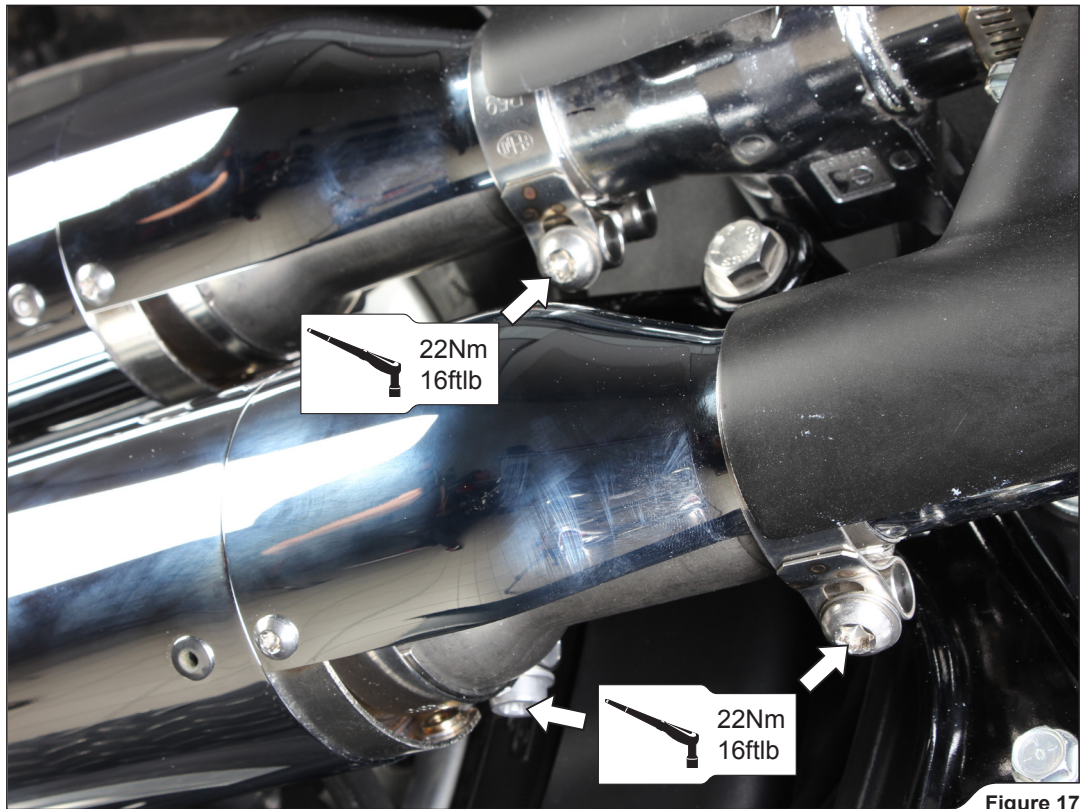

Figure 16



7. Tighten original bracket onto the chassis (Figure 19).

! **CAUTION:** be careful not to damage any part of the motorcycle during this process!

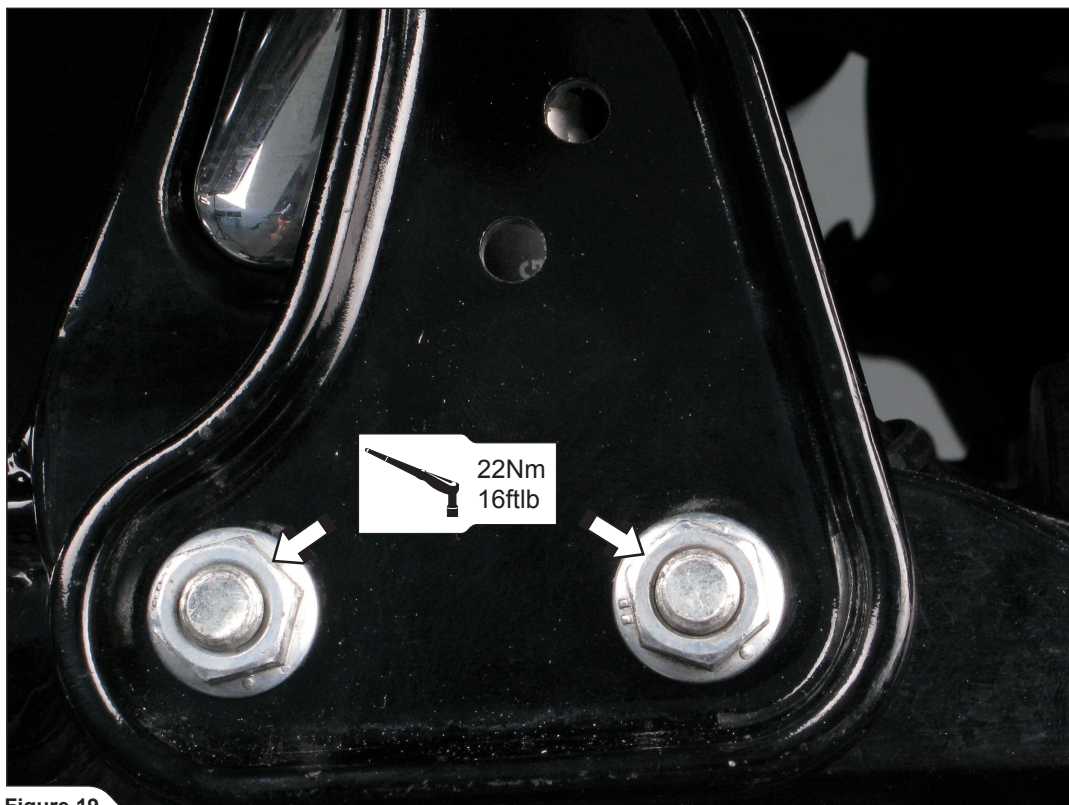

Figure 19

8. Align the original heat shield and tighten the marked tape clamps to a specified torque. Assemble the front header's bracket and tighten both headers' nuts to the specified torque (Figure 20).

! **CAUTION:** be careful not to damage any part of the motorcycle during this process!

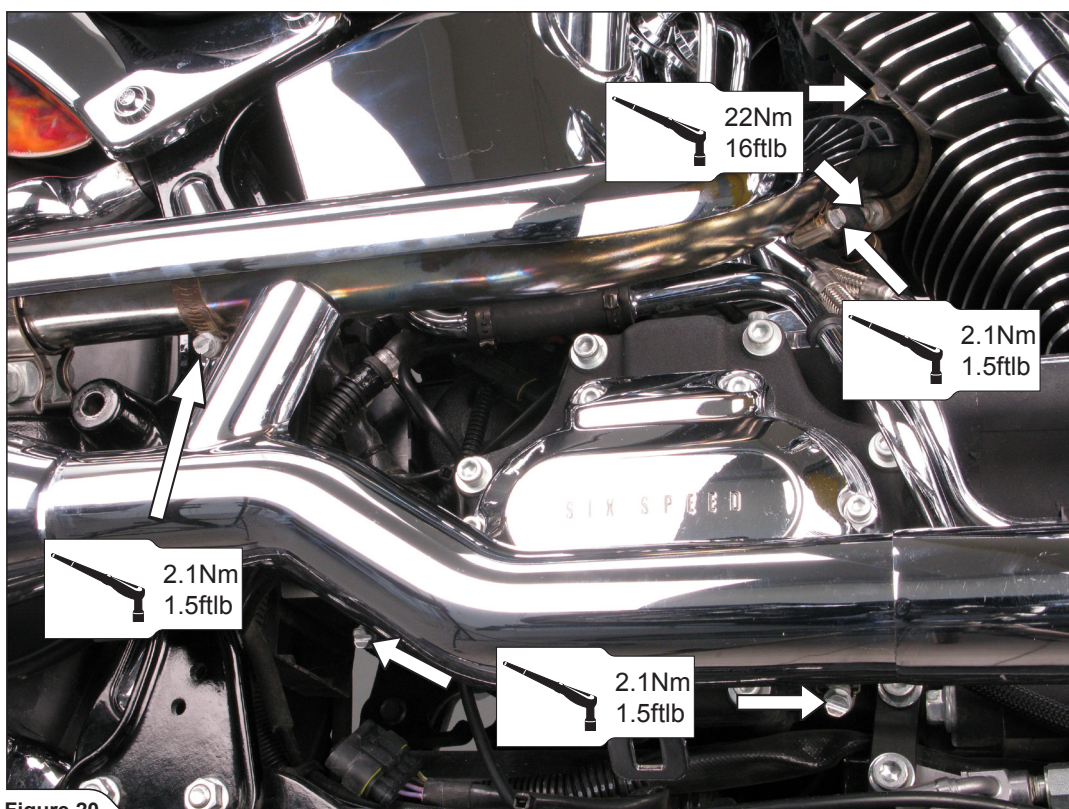

Figure 20

9. Tighten marked bracket bolt with the specified torque (**Figure 21**).

! CAUTION: be careful not to damage any part of the motorcycle during this process!

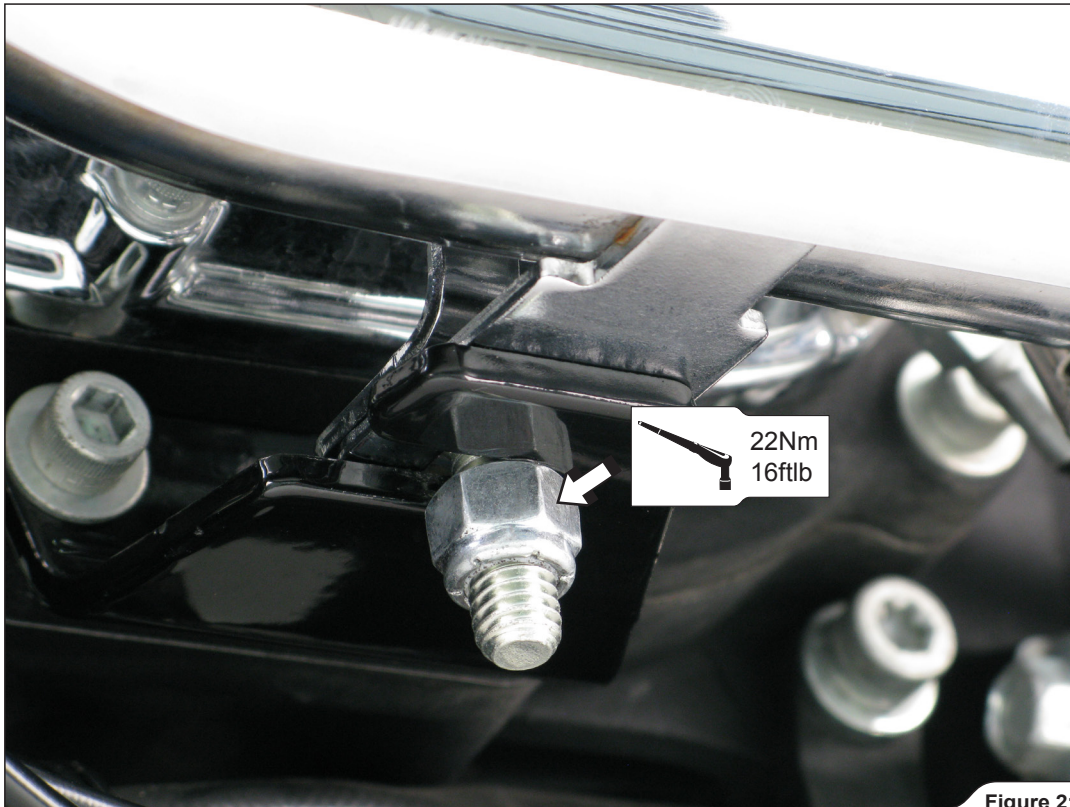

Figure 21

10. Reinstall the footrest bracket and footrest (**Figure 22**).

! WARNING: make sure, not to damage any part of the motorcycle during this procedure!

✘ INSTALLATION TIP: tightening torque for footrest bracket: 22Nm/16ftlb.



Figure 22

Final installation:

Clean grease spots:

- a. Muffler – titanium outer sleeve: use a soft cloth sprayed with a multi-purpose spray lubricant (WD-40 or equivalent).
- b. Muffler – carbon-fiber outer sleeve: use a soft dry cloth.
- c. Muffler – carbon-fiber outlet cap: use a soft dry cloth.
- d. Stainless steel pipes: use a soft cloth sprayed with a contact cleaner, then wipe with a soft dry cloth.
- e. Chrome plated parts: use a soft dry cloth.
- f. Titanium pipes: use a soft cloth sprayed with a multi-purpose spray lubricant (WD-40 or equivalent).

Cleaning will prevent spots from burning onto the surface. Do not use aggressive chemical cleaners, because they can damage the sticker.

! WARNING: make sure all the bolts are sufficiently tightened. In case the exhaust system touches the cowling or other parts repeat the adjustment of the exhaust system or contact your authorized dealer.

! WARNING: after running engine for 30 minutes, retighten the bolts of the Akrapovic carbon-fiber heat shield!

! IT IS NORMAL IF WHITE SMOKE COMES OUT OF THE MUFFLER ON FIRST OPERATION.

! DO NOT STAND BEHIND THE MUFFLER ON FIRST OPERATION.

! DO NOT USE AUTOMOTIVE WHEEL CLEANERS OR ANY CLEANING PRODUCTS WHICH CONTAIN ACIDIC ADDITIVES TO CLEAN AKRAPOVIČ EXHAUST SYSTEMS.

MAINTENANCE OF THE AKRAPOVIČ EXHAUST SYSTEM:

1. Clean the titanium exhaust components with a multi-purpose spray lubricant (WD-40 or equivalent), carbon fiber exhaust components with soft and dry cloth and stainless steel components with soft cloth sprayed with contact cleaner, then wipe with soft and dry cloth. A change in the color of the exhaust system is normal due to the high temperatures.
2. Periodically make sure all the bolts and springs are sufficiently tight.

WARNING:

Please note that certain aftermarket exhaust systems may not comply with applicable California laws and regulations, and may therefore be prohibited for use on California highways or roads, or on roads or vehicles otherwise subject to emissions control requirements.

Akrapovič exhaust systems for automobiles and motorcycles mounted downstream of the catalytic converter (also known as “cat-back systems”) are considered “replacement parts” in California by the California Air Resources Board (CARB), and do not require an exemption or executive order from CARB to be sold in California. However, California prohibits the use of any aftermarket exhaust system that modifies, removes or replaces original equipment catalysts, unless CARB has issued an Executive Order as to such part or system.

Further, Akrapovič parts or exhaust systems used or intended for use on “racing vehicles” (i.e. a competition vehicle used exclusively for competition on closed-course circuits) do not require an exemption or Executive Order from CARB to be sold in California. However, such parts are prohibited from use on California public highways or roads, even if occasionally used “off-road.”

